

Design like lifestyle

NIGHT & DAY COLLECTION 2.0

Innovation solution of design
for contemporary home



 **alterego**[®]
divani
MADE IN ITALY



CHI SIAMO

Creata nel 2006, con un'esperienza trentennale alle spalle, Alterego divani è specializzata nella produzione di divani, poltrone e letti di ogni tipologia. Imbottiti dalle linee classiche o avveniristiche, straordinaria qualità dei materiali e delle lavorazioni eseguite secondo l'ottica artigiana del Made in Italy. L'obiettivo dell'azienda è, infatti, soddisfare ogni richiesta offrendo qualità, funzionalità ed innovazione.

Created in 2006, with thirty years of experience behind him, Alterego sofas specializes in the production of sofas, armchairs and beds of all types. Upholstered furniture with classic or futuristic lines, extraordinary quality of materials and workmanship performed according to the artisan optic Made in Italy. The company's goal is; in fact, meet all requirements by offering quality, functionality and innovation.

CONTRACT

ALTEREGO DIVANI si è subito distinta per l'estrema attenzione e dedizione allo studio di prodotti specifici per il "contract"; con la collezione Alterego divani, nel tempo ha sviluppato un prezioso "know-how", che oggi consente di offrire una gamma completa in grado di soddisfare ogni esigenza estetica e funzionale, realizzando anche divani e poltrone nelle versioni fisse e letto anche su disegno.

ALTEREGO DIVANI became immediately focused and dedicated to studying specific products for the "contract" market; Alterego divani with its entire collection has developed over time a valuable "know-how" enabling us to offer a complete range, capable of meeting all aesthetics and functional requirements such as sofas and armchairs in fixed or bed versions, including the customers own unique design.

UN PRODOTTO INTERAMENTE REALIZZATO A MANO NELLA NOSTRA AZIENDA.

Tutti i nostri prodotti sono caratterizzati da elevati standard di qualità e design ricercato che sono il frutto dell'impegno e della passione che vengono impiegati nella produzione di ciascun elemento. Gestiamo ogni fase della nostra produzione con cura, arrivando sino ai dettagli, punto di forza di Alterego divani. Le cuciture rappresentano poi un passaggio fondamentale e variano a seconda della posizione in cui sono chiamate a intervenire. La lavorazione e i tessuti applicati ai nostri prodotti si ispirano a criteri artigianali e procedimenti antichi, indispensabili per salvaguardare il manufatto dalle imperfezioni. Il nostro obiettivo è quello di offrire alla clientela più esigente la possibilità di selezionare il rivestimento per il proprio imbottito, scegliendo tra una vastissima collezione di tessuti.

AN ENTIRELY HAND MADE PRODUCT IN OUR COMPANY.

All our products are characterized by high standards of quality and design that are the result of our commitment and passion. We carefully manage every phase of our production, until the details, strong point of ALTEREGO sofas. The seams represent a fundamental step and vary according to the different positions. The workmanship and the fabrics applied to our products are inspired by artisanal criteria and ancient procedures, indispensable for safeguarding the products from the imperfections. Our goal is to offer the most demanding customers the possibility to select the upholstery for their Sofa, choosing from a vast collection of fabrics.

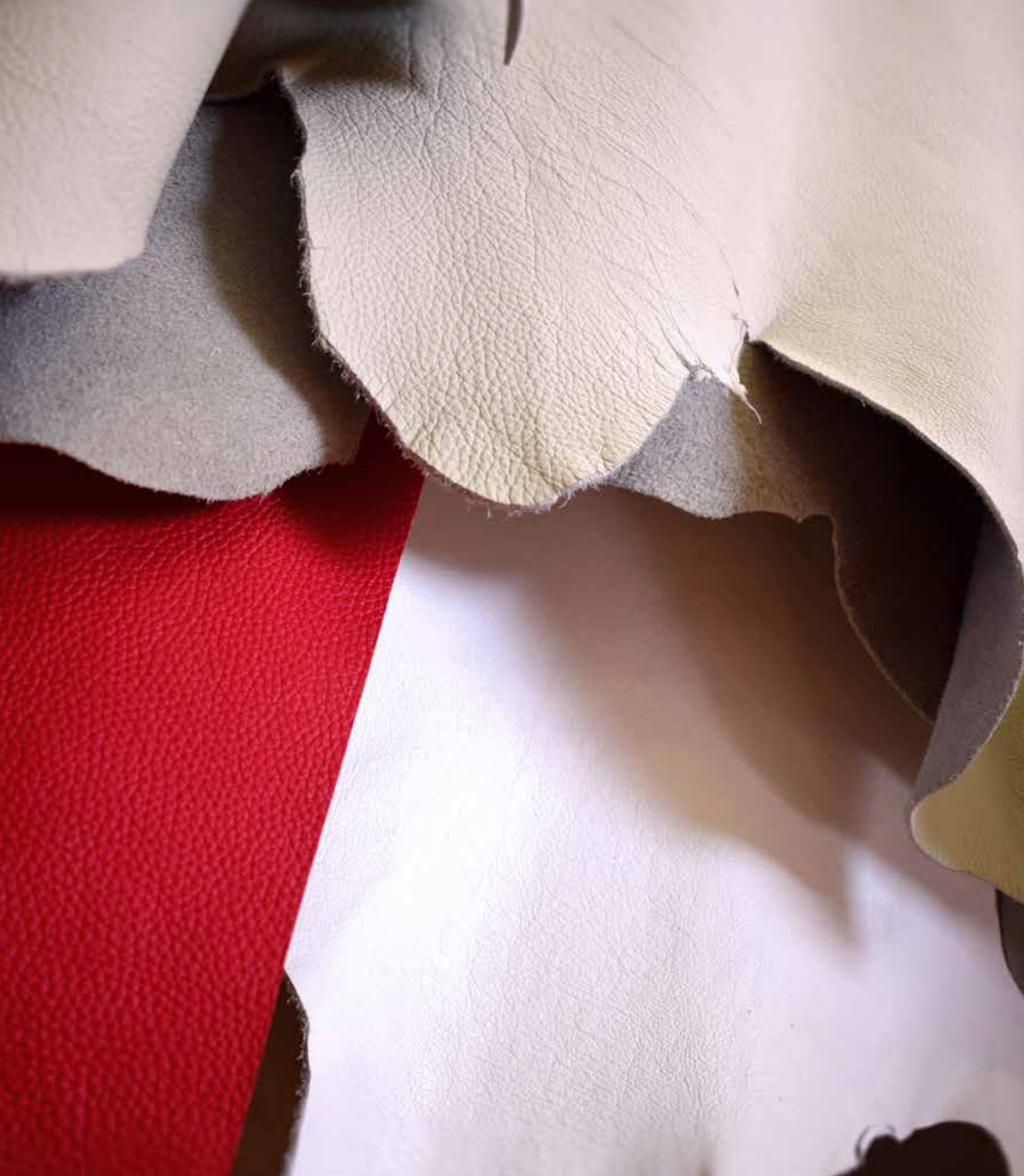

L'ARTE DEL VERO MADE IN ITALY

Prima di essere un prodotto, ALTEREGO DIVANI è un'emozione.

Uno spazio dentro il quale si creano opere d'arte. Un ambiente che coinvolge anima e corpo, nel quale si entra a far parte direttamente dell'esperienza artistica. Un luogo dove la qualità e la manifattura sono il risultato della grande tradizione artigianale italiana.

Da sempre ALTEREGO DIVANI produce con cura e dedizione, usando solo componenti e materiali di produzione nazionale, che rispettano i più elevati standard qualitativi.

THE ART OF THE REAL MADE IN ITALY

Before being a product, ALTEREGO DIVANI is first of all an emotion. A space in which works of art are created. An environment that captivates body and soul, in which you can join artistic experience directly.

A place where quality and italian manufacturer are the result of the greatitalian craft tradition.

ALTEREGO DIVANI always produces its "works of art" with love and dedication, using high quality italian materials and components which meet high quality standards.

Made in Italy

DIVANI.FISSI | SOFA.FIX

01 RICHMOND p.12



02 SINGAPORE p.20



03 TOKYO p.28



04 NEW YORK p.36



05 MANCHESTER p.44



06 VALENCIA p.52



07 PAMPLONA p.62



POLTRONE | ARMCHAIRS

27 MOON p.242



28 FUNNY p.244



29 OMAR p.245



30 TAIPEI p.246



31 LAGOS p.248



32 ATENE p.250



33 MUNICH p.252



34 PRETTY p.254



35 SANTIAGO p.256



36 SQUARE p.260



DIVANI.LETTO | SOFA.BED

08 DALLAS p.70



09 ZEUS p.80



10 ODINO p.90



11 THOR p.100



12 NIZZA p.110



13 DUBAI p.120



14 DAKAR p.130



15 MABEL p.140



16 STEP p.150



17 ELOISE p.158



18 STILOSO p.166



19 LOIS p.176



20 SLIDE p.184



21 REVERS p.192



22 ROCKY p.206



23 SHINE p.214



24 MIRA p.222



25 MARLEN p.228



26 CHANTAL p.234



OPZIONI | OPTIONS



MATERASSI
MATTRESS p.261



MECCANICHE
MECHANICAL p.268

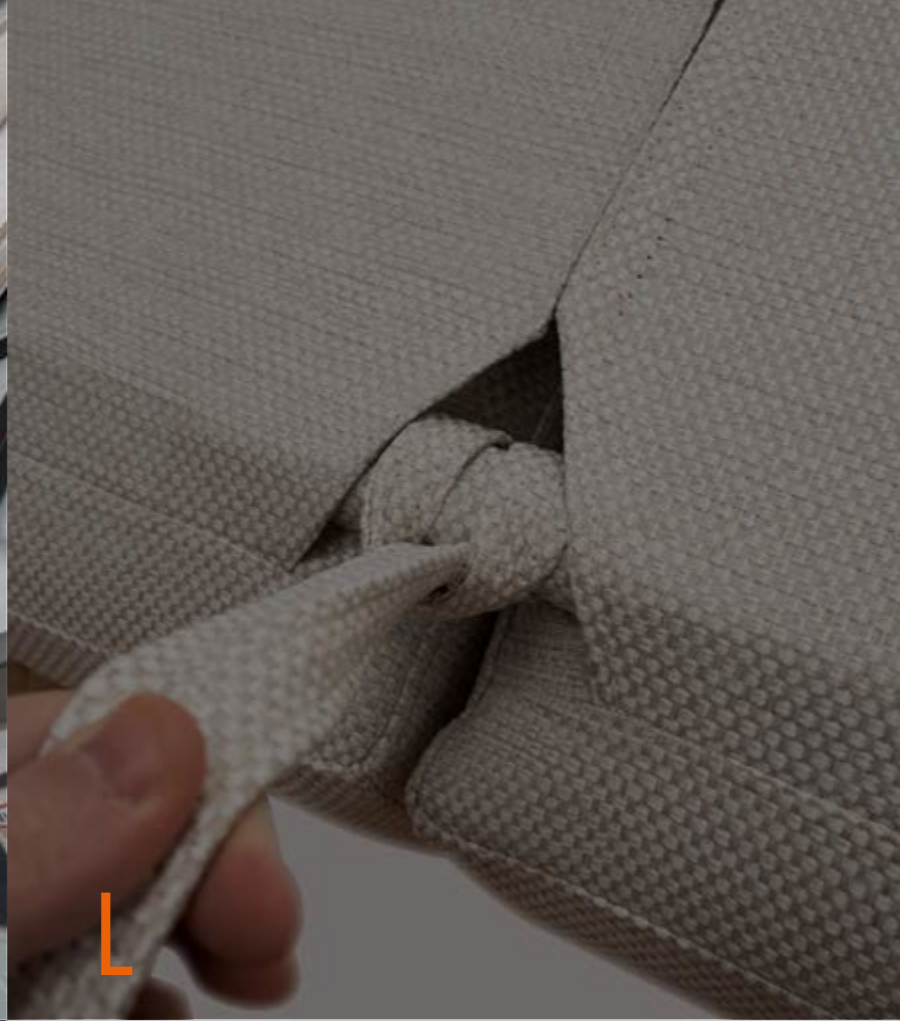



I particolari,
curati nei minimi dettagli,
rendono Alterego divani un marchio di
eccellenza per qualità e ricercatezza nei
materiali



The details,
make Alterego sofas a brand
of excellence for quality
and refinement in materials.



RICHMOND

13
RICHMOND /

Il divano Richmond risponde
a pieno alle esigenze di
spazio ed estetica degli
ambienti moderni.

The sofa Richmond responds
fully to the needs of space and
aesthetics of modern interiors.





I particolari
generano l'insieme.
The details generate
the whole.



STRUTTURA:
 Agglomerato di legno foderato con tessuto vellutino termoaccoppiato ad un sottile strato di poliuretano espanso.
IMBOTTITURE:
 Cuscini di seduta in gomma doppia densità 35/28 kg/mc e fibra sintetica 200 g/mc.
 Cuscini di spalliera densità super soft SS 18 kg/mc.
RIVESTIMENTO:
 Interamente sfoderabile.
 Per la variante ecopelle o pelle sfoderabile solo la cuscineria.

STRUCTURE:
 Wooden agglomerate lined with fine velvet fabric thermocoupled to a thin layer of polyurethane foam.
CUSHIONS PADDING:
 Seat cushions rubber in double density 35/28 kg/mc and synthetic fiber 200 g/mc.
 Back cushions density super soft SS 18 kg/mc.
COVER:
 Completely removable.
 In artificial leather or leather removable only cushions.

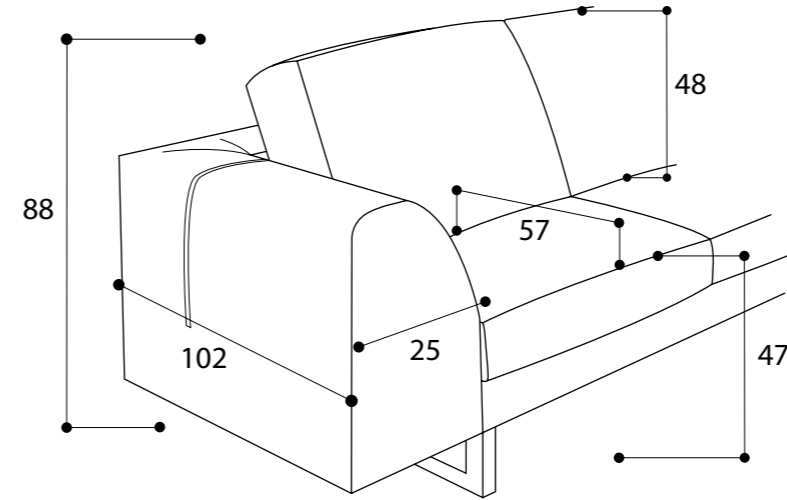

Disponibile con piedini /
 available with feet /

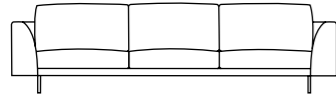
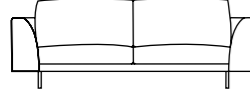

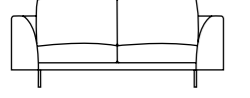
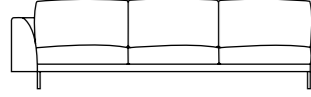
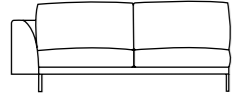
Dimensione con braccioli tipo / Size with armrests type		A
	4 posti fisso 4 places fix	270
	3 posti max fisso 3,5 places fix	244
	3 posti fisso 3 places fix	234
	Intermedio fisso 2,5 places fix	224
	2 posti fisso 2 places fix	204
	4 posti laterale fisso - bracciolo DX o SX 4 lateral places - armrest DX o SX	245
	3 posti max laterale fisso - bracciolo DX o SX 3,5 lateral places - armrest DX o SX	219

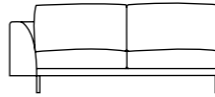
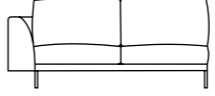
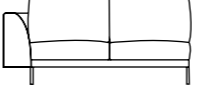
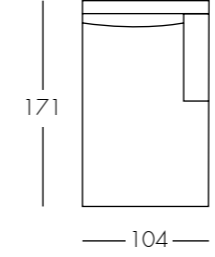
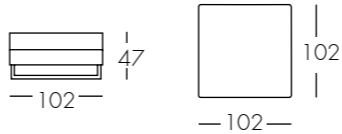
Dimensione con braccioli tipo / Size with armrests type		A
	3 posti laterale fisso - bracciolo DX o SX 3 lateral places fix - armrest DX o SX	209
	Intermedio laterale fisso - bracciolo DX o SX 2,5 lateral places fix - armrest right or left	199
	2 posti laterale fisso - bracciolo DX o SX 2 lateral places fix - armrest DX o SX	179
	Chaiselongue laterale fissa bracciolo DX o SX lateral fixed chaiselongue armrest DX o SX	104
	Pouff fisso/contenitore Fixed/stored pouf	



Una presenza che da sola è
protagonista nel salone.

A presence that alone is the
protagonist of the environment.



Una presenza che da sola è
protagonista nel salone.

A presence that alone is the
protagonist of the environment.



24
SINGAPORE /



25
SINGAPORE /
3P + CHAISERLONGUE

STRUTTURA:
 Agglomerato di legno foderato con tessuto vellutino termoaccoppiato ad un sottile strato di poliuretano espanso.
IMBOTTITURE:
 Cuscini di seduta in gomma doppia densità 35/28 kg/mc e fibra sintetica 200 g/mc.
 Cuscini di spalliera in fiocco ricoperto di fibra sintetica.
RIVESTIMENTO:
 Interamente sfoderabile.
 Per la variante ecopelle o pelle sfoderabile solo la cuscineria.

STRUCTURE:
 Wooden agglomerate lined with fine velvet fabric thermocoupled to a thin layer of polyurethane foam.
CUSHIONS PADDING:
 Seat cushions rubber in double density 35/28 kg/mc and synthetic fiber 200 g/mc. Back cushions covered in synthetic staple fiber.
COVER:
 Completely removable.
 In artificial leather or leather removable only cushions.



Disponibile con piedini / available with feet /

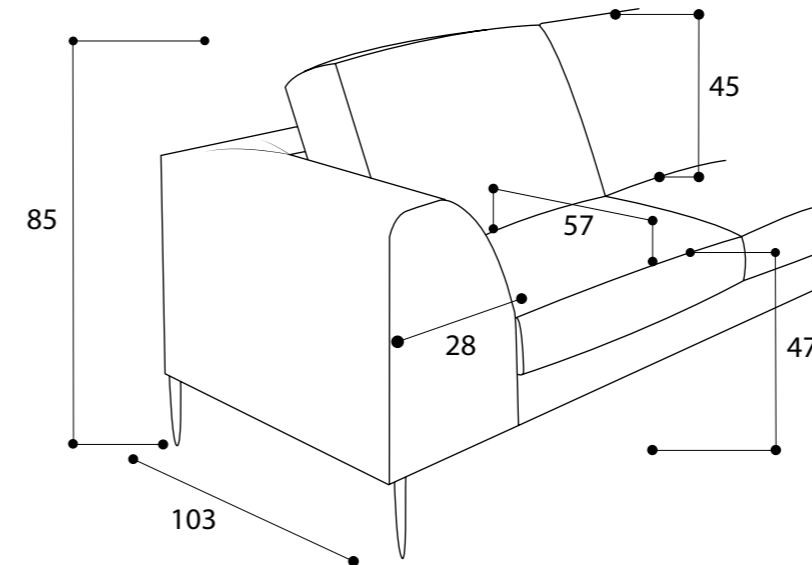

Dimensione con braccioli tipo / Size with armrests type

Dimensione con braccioli tipo / Size with armrests type		A
	3 posti max fisso 3,5 places fix	246
	3 posti fisso 3 places fix	236
	Intermedio fisso 2,5 places fix	226
	2 posti fisso 2 places fix	206
	3 posti max laterale fisso - bracciolo DX o SX 3,5 lateral places - armrest DX o SX	218
	3 posti laterale fisso - bracciolo DX o SX 3 lateral places fix - armrest DX o SX	208

Dimensione con braccioli tipo / Size with armrests type

Dimensione con braccioli tipo / Size with armrests type		A
	Intermedio laterale fisso - bracciolo DX o SX 2,5 lateral places fix - armrest right or left	198
	2 posti laterale fisso - bracciolo DX o SX 2 lateral places fix - armrest DX o SX	178
	Chaiselongue laterale fissa bracciolo DX o SX Lateral fixed chaiselongue armrest DX o SX	104
	Pouff fisso/contenitore Fixed/storaged pouf	47 103

TOKYO



29
TOKYO /
3P + CHAISÉLONGUE



30
TOKYO /

Estremamente comodo
e perfetto per ogni ambiente.

Extremely comfortable and
perfect for any environment.



31
TOKYO / 3P



STRUTTURA:
 Agglomerato di legno foderato con tessuto vellutino termoaccoppiato ad un sottile strato di poliuretano espanso.
IMBOTTITURE:
 Cuscini di seduta in gomma doppia densità 35/28 kg/mc e fibra sintetica 200 g/mc.
 Cuscini di spalliera densità super soft SS 18 kg/mc.
RIVESTIMENTO:
 Interamente sfoderabile.
 Per la variante ecopelle o pelle sfoderabile solo la cuscineria.



STRUCTURE:
 Wooden agglomerate lined with fine velvet fabric thermocoupled to a thin layer of polyurethane foam.
CUSHIONS PADDING:
 Seat cushions rubber in double density 35/28 kg/mc and synthetic fiber 200 g/mc.
 Back cushions density super soft SS 18 kg/mc.
COVER:
 Completely removable.
 In artificial leather or leather removable only cushions.

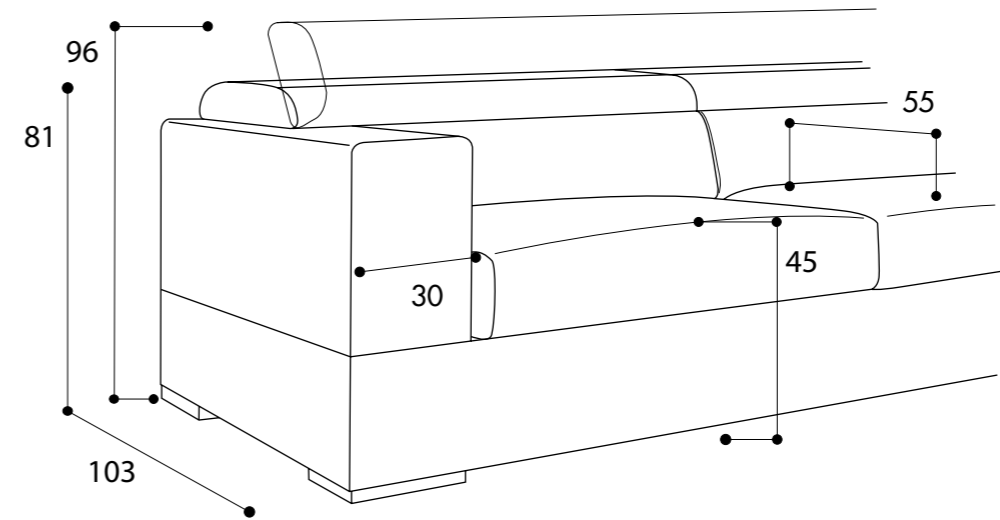

Disponibile con piedini / available with feet /

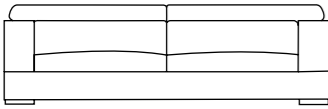
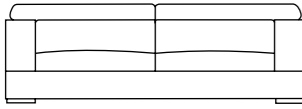
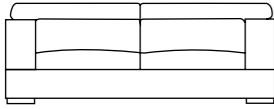
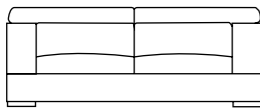
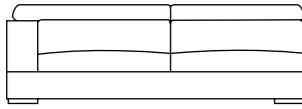
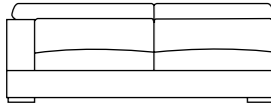

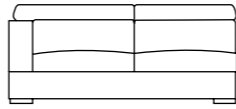
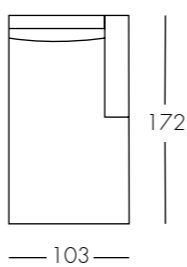
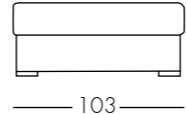
Dimensione con braccioli tipo / Size with armrests type		A
	3 posti max fisso 3,5 places fix	244
	3 posti fisso 3 places fix	224
	Intermedio fisso 2,5 places fix	204
	2 posti fisso 2 places fix	184
	3 posti max laterale fisso - bracciolo DX o SX 3,5 lateral places - armrest DX o SX	214
	3 posti laterale fisso - bracciolo DX o SX 3 lateral places fix - armrest DX o SX	194

Dimensione con braccioli tipo / Size with armrests type		A
	Intermedio laterale fisso - bracciolo DX o SX 2,5 lateral places fix - armrest right or left	174
	2 posti laterale fisso - bracciolo DX o SX 2 lateral places fix - armrest DX o SX	154
	Chaiselongue laterale fissa bracciolo DX o SX Lateral fixed chaiselongue armrest DX o SX	104
 	Pouff fisso/contenitore Fixed/storaged pouf	

NEW YORK



I piedini in metallo arricchiscono
l'estetica del divano
donandogli un senso di leggerezza.

The metal feet enrich the aesthetics of the
sofa giving it a sense of lightness.



Il comfort è garantito dai generosi braccioli
e dal poggiatesta regolabile.

The comfort is guaranteed by the generous arms
and the adjustable headrest.



STRUTTURA:
 Agglomerato di legno foderato con tessuto vellutino termoaccoppiato ad un sottile strato di poliuretano espanso.
IMBOTTITURE:
 Cuscini di seduta in gomma doppia densità 35/28 kg/mc e fibra sintetica 200 g/mc.
 Cuscini di spalliera densità super soft SS 18 kg/mc.
RIVESTIMENTO:
 Interamente sfoderabile.
 Per la variante ecopelle o pelle sfoderabile solo la cuscineria.

STRUCTURE:
 Wooden agglomerate lined with fine velvet fabric thermocoupled to a thin layer of polyurethane foam.
CUSHIONS PADDING:
 Seat cushions rubber in double density 35/28 kg/mc and synthetic fiber 200 g/mc.
 Back cushions density super soft SS 18 kg/mc.
COVER:
 Completely removable.
 In artificial leather or leather removable only cushions.



Disponibile con piedini / available with feet /

PNY

PSP

Dimensione con braccioli tipo / Size with armrests type

A

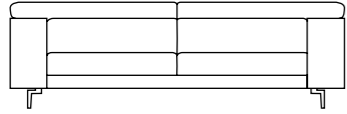
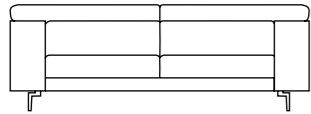
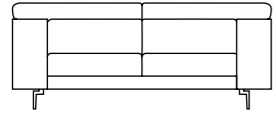
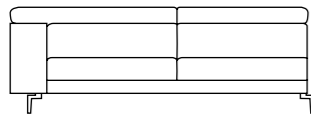
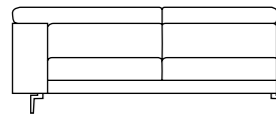
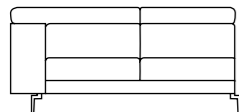
	3 posti max fisso 3,5 places fix	230
	3 posti fisso 3 places fix	210
	Intermedio fisso 2,5 places fix	190
	3 posti max laterale fisso - bracciolo DX o SX 3,5 lateral places - armrest DX o SX	205
	3 posti laterale fisso - bracciolo DX o SX 3 lateral places fix - armrest DX o SX	185
	Intermedio laterale fisso - bracciolo DX o SX 2,5 lateral places fix - armrest right or left	165

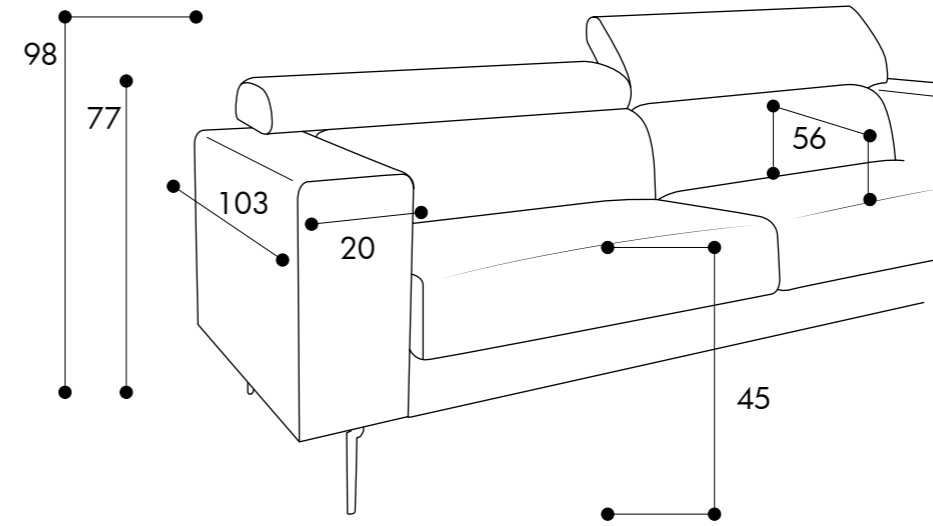

Dimensione con braccioli tipo / Size with armrests type

A

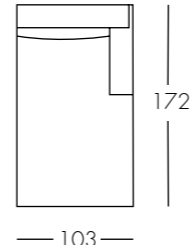
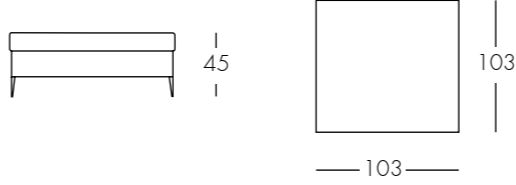
	Chaiselongue laterale fissa bracciolo DX o SX lateral fixed chaiselongue armrest DX o SX	103
	Pouff fisso/contenitore Fixed/storaged pouf	

MANCHESTER



Il comfort è garantito dai generosi braccioli
e dal poggiatesta regolabile.

The comfort is guaranteed by the generous arms
and the adjustable headrest.



46
MANCHESTER /
3 PLACES





Estremamente comodo
e perfetto per ogni ambiente.

Extremely comfortable and
perfect for any environment.



49
MANCHESTER /
3P MAX + CHAISERLONGUE

STRUTTURA:
 Agglomerato di legno foderato con tessuto vellutino termoaccoppiato ad un sottile strato di poliuretano espanso.
IMBOTTITURE:
 Cuscini di seduta in gomma doppia densità 35/28 kg/mc e fibra sintetica 200 g/mc.
 Cuscini di spalliera densità super soft SS 18 kg/mc.
RIVESTIMENTO:
 Interamente sfoderabile.
 Per la variante ecopelle o pelle sfoderabile solo la cuscineria.

STRUCTURE:
 Wooden agglomerate lined with fine velvet fabric thermocoupled to a thin layer of polyurethane foam.
CUSHIONS PADDING:
 Seat cushions rubber in double density 35/28 kg/mc and synthetic fiber 200 g/mc.
 Back cushions density super soft SS 18 kg/mc.
COVER:
 Completely removable.
 In artificial leather or leather removable only cushions.



Disponibile con piedini / available with feet /

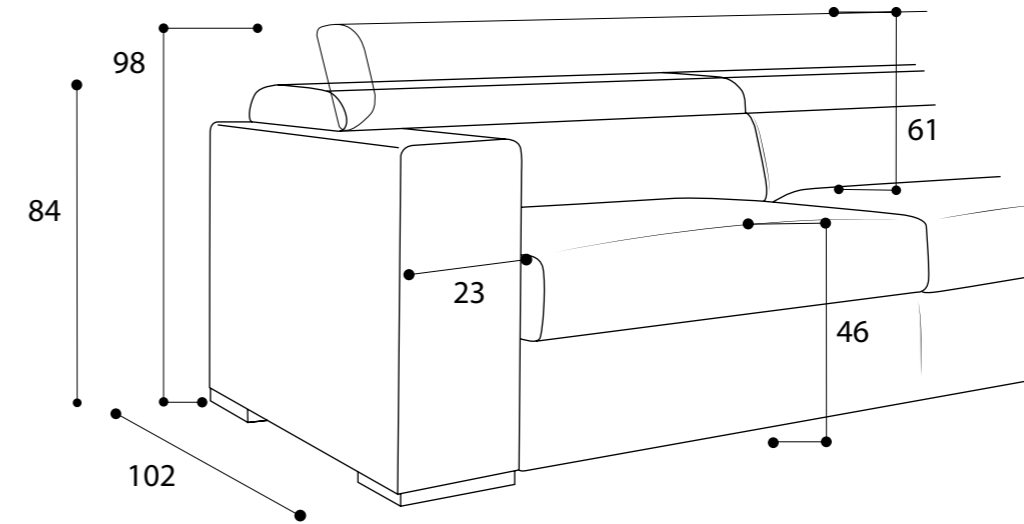

Dimensione con braccioli tipo / Size with armrests type

A

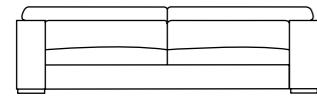

3 posti max fisso
 3,5 places fix

230

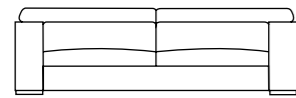

3 posti fisso
 3 places fix

210

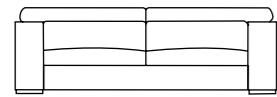

Intermedio fisso
 2,5 places fix

190

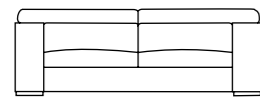

2 posti fisso
 2 places fix

170



3 posti max laterale fisso -
 bracciolo DX o SX
 3,5 lateral places - armrest
 DX o SX

207

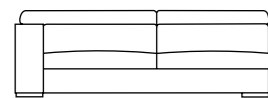

3 posti laterale fisso - bracciolo
 DX o SX
 3 lateral places fix - armrest DX
 o SX

187

Dimensione con braccioli tipo / Size with armrests type

A



Intermedio laterale fisso -
 bracciolo DX o SX
 2,5 lateral places fix - armrest
 right or left

167

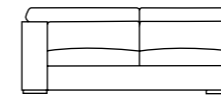

2 posti laterale fisso -
 bracciolo DX o SX
 2 lateral places fix -
 armrest DX o SX

147

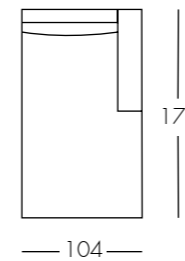

Chaiselongue laterale fissa
 bracciolo DX o SX
 Lateral fixed chaiselongue
 armrest DX o SX

104

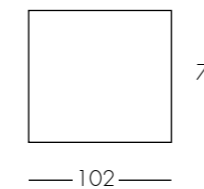
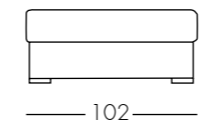

Pouff fisso/contenitore
 Fixed/storaged pouf

VALENCIA

52
VALENCIA /
3P / 1 RECLINER +
ROUND CORNER +
3P LATERAL FIX



54

VALENCIA /



L'efficienza nella morbidezza.
The efficiency in the softness.

Coniuga bellezza,
funzionalità e comfort.
The perfect coniugation of beauty,
functionality and comfort.

Si caratterizza per
componibilità, comfort ed estetica.

It is characterized by
modular lines, comfort and modern
aesthetics.



Si caratterizza per
componibilità, comfort ed estetica.

It is characterized by
modular lines, comfort and modern
aesthetics.



STRUTTURA:
 Agglomerato di legno foderato con tessuto vellutino termoaccoppiato ad un sottile strato di poliuretano espanso.
IMBOTTITURE:
 Cuscini di seduta in gomma densità 30 kg/m³ e fibra sintetica 200 g/m³.
 Cuscini di spalliera densità 18 kg/m³.
RIVESTIMENTO:
 Non sfoderabile

STRUCTURE:
 Wooden agglomerate lined with fine velvet fabric thermocoupled to a thin layer of polyurethane foam.
CUSHIONS PADDING:
 Seat cushions rubber density 30 kg/m³ and synthetic fiber 200 g/m³.
 Back cushions density 18 kg/m³.
COVER:
 Fabric not removable.



Disponibile con piedini / available with feet /

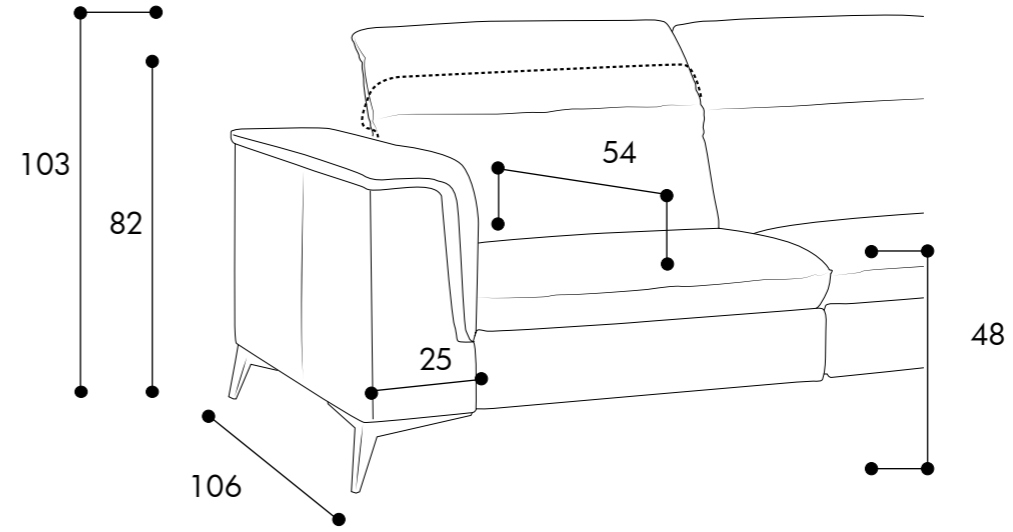
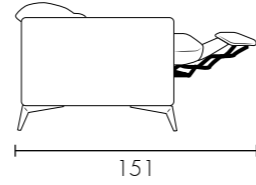

Dimensione con braccioli tipo / Size with armrests type

A

	3 posti fisso 3 places fix	206
	3 posti / 1 recliner elettrico Sx o Dx 3 places / 1 electric recliner Dx o Sx	
	3 posti / 2 recliner elettrico Sx o Dx 3 places / 2 electric recliner Dx o Sx	
	3 posti laterale fisso - bracciolo DX o SX 3 lateral places fix - armrest DX o SX	181
	3 posti laterale con recliner elettrico - bracciolo DX o SX 3 lateral places with electric recliner - armrest DX o SX	
	3 posti laterale con 2 recliner elettriche - bracciolo DX o SX 3 lateral places with 2 electric recliner - armrest DX o SX	
	2 posti fisso 2 places fix	186
	2 posti / 1 recliner elettrico Sx o Dx 2 places / 1 electric recliner Dx o Sx	
	2 posti / 2 recliner elettrico Sx o Dx 2 places / 2 electric recliner Dx o Sx	
	2 posti laterale fisso - bracciolo DX o SX 2 lateral places fix - armrest DX o SX	161
	2 posti laterale con recliner elettrico - bracciolo DX o SX 2 lateral places with electric recliner - armrest DX o SX	
	2 posti laterale con 2 recliner elettriche - bracciolo DX o SX 2 lateral places with 2 electric recliner - armrest DX o SX	
	Poltrona MAXI Armchair MAXI fix	128
	Poltrona MAXI con recliner elettrico Armchair MAXI with electric recliner	
	Poltrona Armchair fix	118
	Poltrona con recliner elettrico Armchair with electric recliner	

Dimensione con braccioli tipo / Size with armrests type

A

	Poltrona laterale MAXI - bracciolo DX o SX Armchair lateral MAXI fix - armrest DX o SX	103
	Poltrona laterale MAXI con recliner elettrico bracciolo DX o SX Armchair lateral MAXI with electric recliner - armrest DX o SX	
	Poltrona laterale - bracciolo DX o SX Armchair lateral fix - armrest DX o SX	93
	Poltrona laterale con recliner elettrico bracciolo DX o SX Armchair lateral with electric recliner - armrest DX o SX	
	Poltrona MAXI senza bracciolo Armchair MAXI without armrest	78
	Poltrona MAXI senza bracciolo con recliner Armchair MAXI without armrest with electric recliner	
	Poltrona senza bracciolo Armchair without armrest	68
	Poltrona senza bracciolo con recliner Armchair without armrest with electric recliner	
	Angolo tondo Rounding corner	130
	Chaiselongue laterale fissa bracciolo DX o SX Lateral fixed chaiselongue armrest DX o SX	103
	Pouff fisso Fixed pouf	106



PAMPLONA

Unico nel suo genere,
unisce qualità e comfort.
Unique in his category, combine
quality and comfort.



64
PAMPLONA /



Coniuga bellezza,
funzionalità e comfort.
The perfect coniugation of beauty,
functionality and comfort.



66
PAMPLONA /

Dettagli di design contribuiscono
all'identificazione di un'estetica
contemporanea.

Design details contribute in the
identification of a
contemporary aesthetic.



67
PAMPLONA /

STRUTTURA:
 Agglomerato di legno foderato con tessuto vellutino termoaccoppiato ad un sottile strato di poliuretano espanso.
IMBOTTITURE:
 Cuscini di seduta in gomma densità 35 kg/mc e fibra sintetica 200 g/m³.
 Cuscini di spalliera densità 21S kg/m³.
RIVESTIMENTO:
 Non sfoderabile.

STRUCTURE:
 Wooden agglomerate lined with fine velvet fabric thermocoupled to a thin layer of polyurethane foam.
CUSHIONS PADDING:
 Seat cushions rubber density 35 kg/m³ and synthetic fiber 200 g/m³.
 Back cushions density 21S kg/m³.
COVER:
 Fabric not removable.



Disponibile con piedini / available with feet /

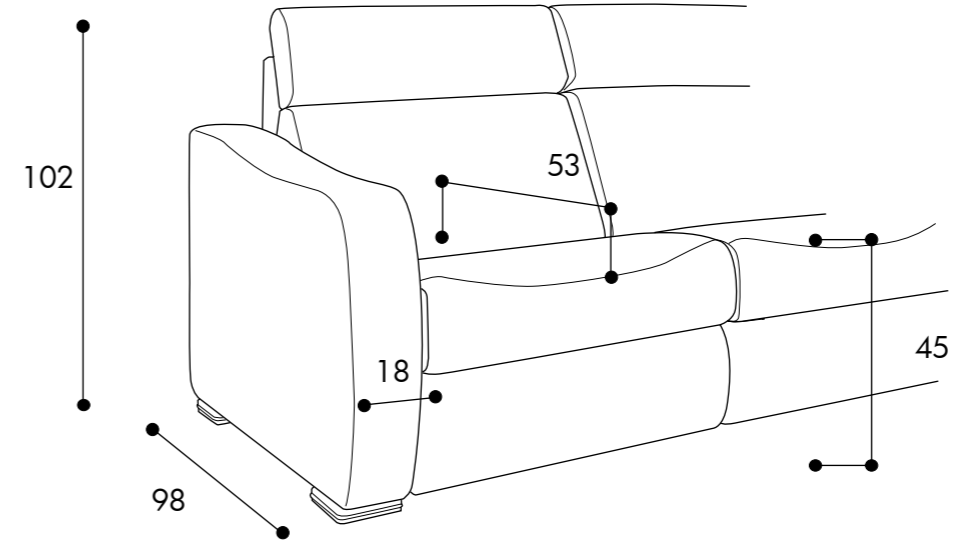
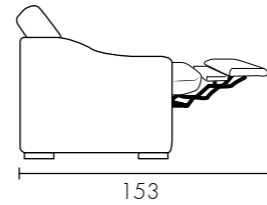

Dimensione con braccioli tipo / Size with armrests type

A

	3 posti fisso 3 places fix	192
	3 posti / 1 recliner elettrico Sx o Dx 3 places / 1 electric recliner Dx o Sx	
	3 posti / 2 recliner elettrico Sx o Dx 3 places / 2 electric recliner Dx o Sx	
	2 posti fisso 2 places fix	172
	2 posti / 1 recliner elettrico Sx o Dx 2 places / 1 electric recliner Dx o Sx	
	2 posti / 2 recliner elettrico Sx o Dx 2 places / 2 electric recliner Dx o Sx	
	3 posti laterale fisso - bracciolo DX o SX 3 lateral places fix - armrest DX o SX	174
	3 posti laterale con recliner elettrico - bracciolo DX o SX 3 lateral places with electric recliner - armrest DX o SX	
	3 posti laterale con 2 recliner elettriche - bracciolo DX o SX 3 lateral places with 2 electric recliner - armrest DX o SX	
	2 posti laterale fisso - bracciolo DX o SX 2 lateral places fix - armrest DX o SX	154
	2 posti laterale con recliner elettrico - bracciolo DX o SX 2 lateral places with electric recliner - armrest DX o SX	
	2 posti laterale con 2 recliner elettriche - bracciolo DX o SX 2 lateral places with 2 electric recliner - armrest DX o SX	

Dimensione con braccioli tipo / Size with armrests type

A

	Poltrona MAXI Armchair MAXI fix	114
	Poltrona MAXI con recliner elettrico Armchair MAXI with electric recliner	
	Poltrona fissa Armchair fix	104
	Poltrona con recliner elettrico Armchair with electric recliner	
	Chaiselongue laterale fissa / apribile bracciolo DX o SX Lateral fixed chaiselongue armrest DX o SX	96
	Pouff fisso/contenitore Fixed/storaged pouf	

DALLAS



Z1
DALLAS /
SOFA BED

Unico nel suo genere,
unisce qualità e comfort.

Unique in his category,
combine quality and comfort.



72
DALLAS /
SOFA BED



73
DALLAS /
SOFA BED



74
DALLAS /
SOFA BED



Si caratterizza per
componibilità, comfort ed estetica.

It is characterized by
modular lines, comfort and modern
aesthetics.

Dettagli di design contribuiscono all'identificazione di un'estetica contemporanea.

Design details contribute in the identification of a contemporary aesthetic.

Si caratterizza per componibilità, comfort ed estetica.

It is characterized by modular lines, comfort and modern aesthetics.

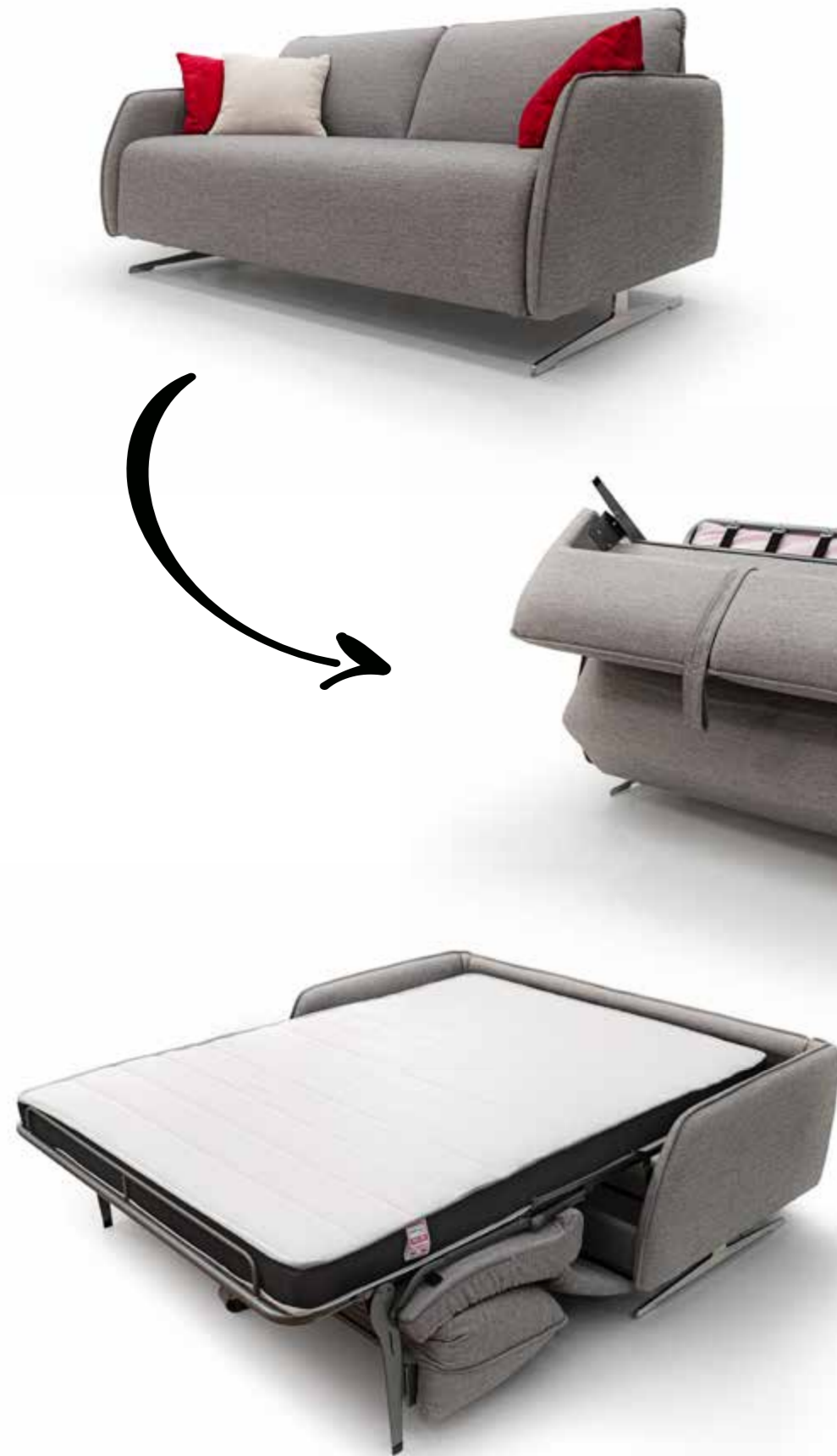

77
DALLAS /
SOFA BED

Divano letto con rete elettrosaldata e cinghie elastiche, materasso H 13 cm.
 Completamente sfoderabile con rivestimento in tessuto. Composto da elementi smontabili per facilitare il trasporto e la sfoderabilità.
 Montaggio degli elementi con sistema a baionetta. Struttura: agglomerato di legno foderato con tessuto vellutino termoaccoppiato ad un sottile strato di poliuretano espanso. Imbottitura: schienali e sedute in poliuretano espanso indeformabile avvolte con falda siliconata.

Sofa bed with electrowelded bed case, elastic belts and mattress H 13 cm.
 Fully removable covers for fabric upholstery.
 Composed by disassembled pieces for an easy transportation or cover removal.
 Assembly of pieces by metal sliding-rail brackets. Structure: wooden agglomerate lined with fine velvet fabric thermocoupled to a thin layer of polyurethane foam.
 Filling: back and seat cushions in indeformable polyurethane foam, silicone coated.

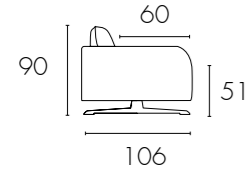

Dimensione con braccioli tipo / Size with armrests type

A

	3 posti max fisso 3,5 places fix		3 posti max letto 3,5 places bed Materasso cm 160 x 197 Mattress cm 160 x 197	202
	3 posti fisso 3 places fix		3 posti letto 3 places bed Materasso cm 140 x 197 Mattress cm 140 x 197	182
	Intermedio fisso 2,5 places fix		Intermedio letto 2,5 places bed Materasso cm 120 x 197 Mattress cm 120 x 197	162
	2 posti fisso 2 places fix		2 posti letto 2 places bed Materasso cm 100 x 197 Mattress cm 100 x 197	142
			Poltrona letto Armchair bed Materasso cm 70 x 197 Mattress cm 70 x 197	112
	Poltrona fissa Armchair fix			82
	3 posti max laterale fisso - bracciolo DX o SX 3,5 lateral places - armrest DX o SX		3 posti max laterale letto - bracciolo DX o SX 3,5 lateral places bed - armrest DX o SX	193
	3 posti laterale fisso - bracciolo DX o SX 3 lateral places fix - armrest DX o SX		3 posti laterale letto - bracciolo DX o SX 3 lateral places bed - armrest DX o SX	173
	Intermedio laterale fisso - bracciolo DX o SX 2,5 lateral places fix - armrest right or left		Intermedio letto - bracciolo DX o SX 2,5 lateral places bed - armrest DX o SX	153



A

9 cm



Dimensione con braccioli tipo / Size with armrests type

A

	2 posti laterale fisso - bracciolo DX o SX 2 lateral places fix - armrest DX o SX		2 posti laterale letto - bracciolo DX o SX 2 lateral places bed - armrest DX o SX	133
			Poltrona laterale letto - bracciolo DX o SX Armchair lateral bed - armrest DX o SX	103
	Poltrona laterale fisso - bracciolo DX o SX Armchair lateral fix - armrest DX o SX			73
	Chaiselongue laterale fissa/apribile bracciolo DX o SX Lateral fixed/storaged chaiselongue armrest DX o SX			92
	Chaiselongue laterale fissa/apribile bracciolo DX o SX Lateral fixed/storaged chaiselongue armrest DX o SX			92
	Pouff fisso/contenitore Fixed/storaged pouf			

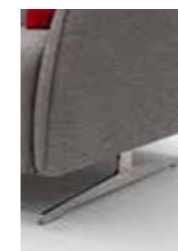

Disponibile con piedini /
available with feet /

ZEUS

81
ZEUS /
SOFA BED



82
ZEUS /
SOFA BED

Lo spazio prende una nuova
forma con
il morbido schienale e i pog-
giatesta reclinabili.

The space has a new shape
with the soft backrest and
reclining headrest.



83
ZEUS /
SOFA BED

Coniuga bellezza,
funzionalità e comfort.
The perfect coniugation of beauty,
functionality and comfort.



84
ZEUS /
SOFA BED



85
ZEUS /
SOFA BED



Dettagli di design contribuiscono all'identificazione di un'estetica contemporanea.

Design details contribute in the identification of a contemporary aesthetic.

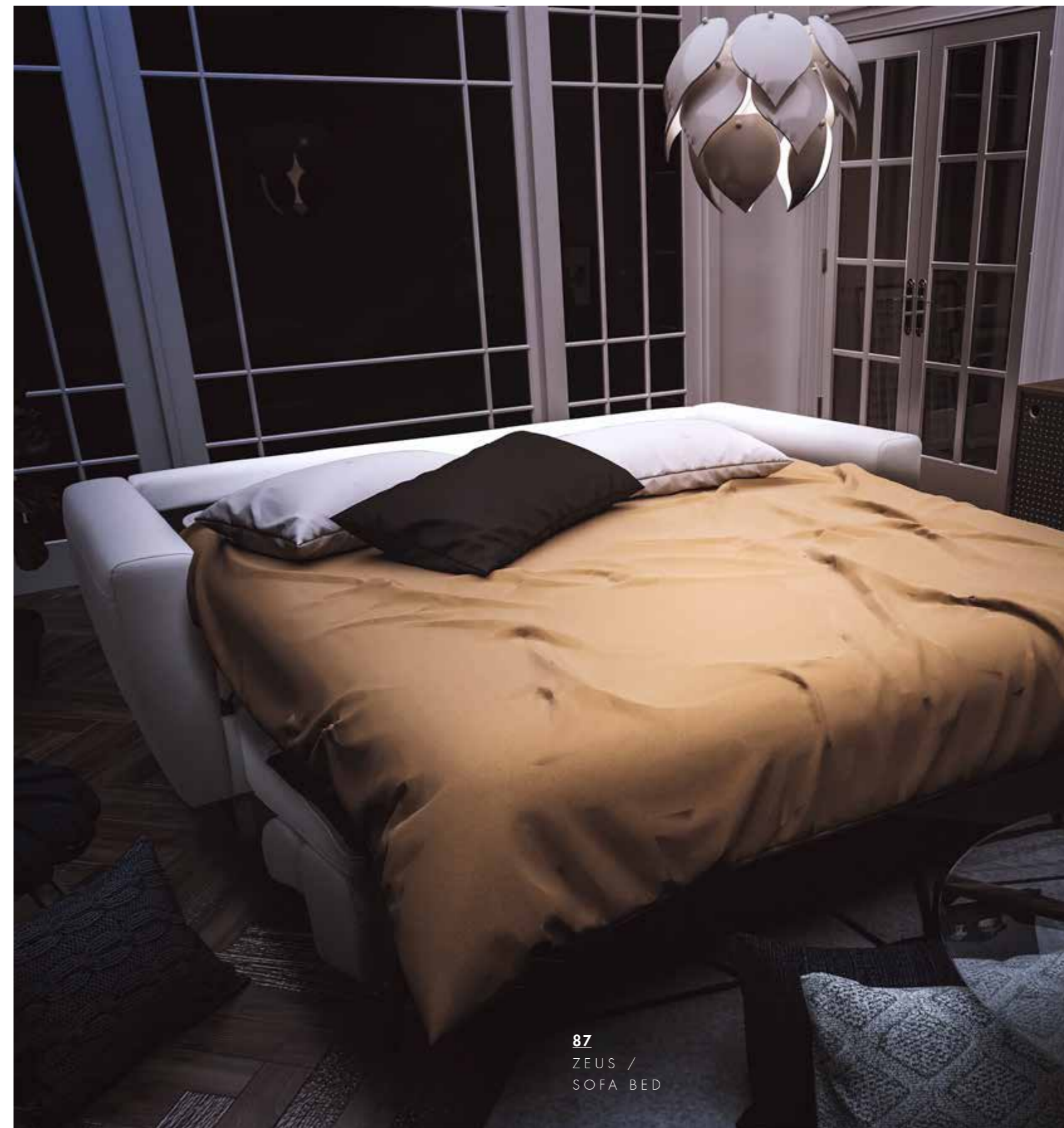
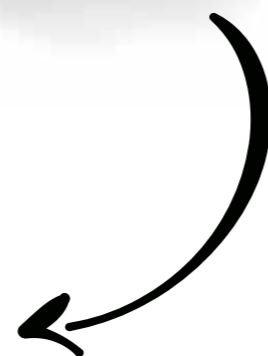
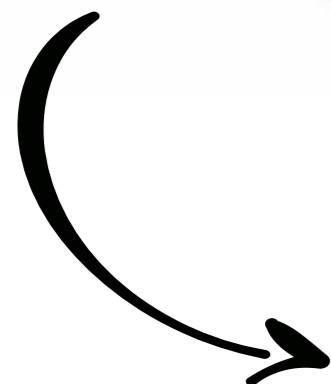

87
ZEUS /
SOFA BED

Divano letto con rete elettrosaldata e cinghie elastiche, materasso H 13 cm.
 Completamente sfoderabile con rivestimento in tessuto. Composto da elementi smontabili per facilitare il trasporto e la sfoderabilità.
 Montaggio degli elementi con sistema a baionetta. Struttura: agglomerato di legno foderato con tessuto vellutino termoaccoppiato ad un sottile strato di poliuretano espanso. Imbottitura: schienali e sedute in poliuretano espanso indeformabile avvolte con falda siliconata.
 Vano porta guanciali su retro schienale.

Sofa bed with electrowelded bed case, elastic belts and mattress H 13 cm .
 Fully removable covers for fabric upholstery.
 Composed by disassembled pieces for an easy transportation or cover removal.
 Assembly of pieces by metal sliding-rail brackets. Structure: wooden agglomerate lined with fine velvet fabric thermocoupled to a thin layer of polyurethane foam.
 Filling: back and seat cushions in indeformable polyurethane foam, silicone coated.
 Pillow compartment on sofa back.

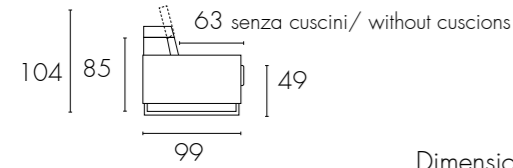

Dimensione con braccioli tipo / Size with armrests type

Dimensione con braccioli tipo / Size with armrests type		A
	3 posti max fisso 3,5 places fix	222
	3 posti max letto 3,5 places bed Materasso cm 160 x 197 Mattress cm 160 x 197	212
	3 posti fisso 3 places fix	202
	3 posti letto 3 places bed Materasso cm 140 x 197 Mattress cm 140 x 197	212
	Intermedio fisso 2,5 places fix	182
	Intermedio letto 2,5 places bed Materasso cm 120 x 197 Mattress cm 120 x 197	212
	2 posti fisso 2 places fix	162
	2 posti letto 2 places bed Materasso cm 100 x 197 Mattress cm 100 x 197	212
	Poltrona letto Armchair bed Materasso cm 70 x 197 Mattress cm 70 x 197	132
	Poltrona fissa Armchair fix	102
	3 posti max laterale fisso - bracciolo DX o SX 3,5 lateral places - armrest DX o SX	201
	3 posti max laterale letto - bracciolo DX o SX 3,5 lateral places bed - armrest DX o SX	212
	3 posti laterale fisso - bracciolo DX o SX 3 lateral places fix - armrest DX o SX	181
	3 posti laterale letto - bracciolo DX o SX 3 lateral places bed - armrest DX o SX	212
	Intermedio laterale fisso - bracciolo DX o SX 2,5 lateral places fix - armrest right or left	161
	Intermedio letto - bracciolo DX o SX 2,5 lateral places bed - armrest DX o SX	212

Dimensione con braccioli tipo / Size with armrests type

Dimensione con braccioli tipo / Size with armrests type		A
	2 posti laterale fisso - bracciolo DX o SX 2 lateral places fix - armrest DX o SX	141
	2 posti laterale letto - bracciolo DX o SX 2 lateral places bed - armrest DX o SX	212
	Poltrona laterale fisso - bracciolo DX o SX Armchair lateral fix - armrest DX o SX	81
	Chaiselongue laterale fissa/apribile bracciolo DX o SX Lateral fixed/storaged chaiselongue armrest DX o SX	106
	Chaiselongue laterale fissa/apribile bracciolo DX o SX Lateral fixed/storaged chaiselongue armrest DX o SX	106
	Pouff fisso/contenitore Fixed/storaged pouf	



Disponibile con piedini /
available with feet /

SLI

PNY

ODINO



90
ODINO /
SOFA BED

Personalità
per spazi confortevoli.

Exceptional character,
exceptional comfort.



92
ODINO /
SOFA BED



93
ODINO /
SOFA BED



94
ODINO /
SOFA BED



Quando il dinamismo
diventa design.

When dynamism
turns into design.

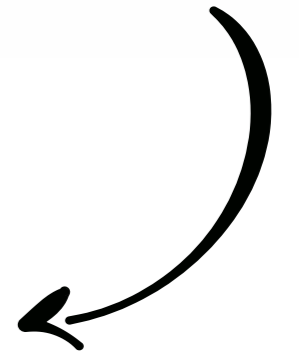
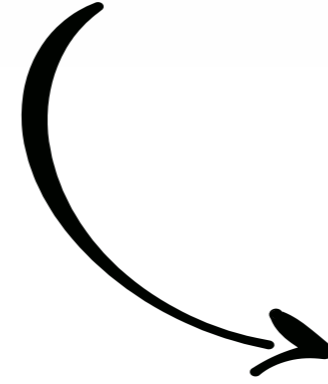

97
ODINO /
SOFA BED

Divano letto con rete elettrosaldata e cinghie elastiche, materasso H 13 cm.
 Completamente sfoderabile con rivestimento in tessuto. Composto da elementi smontabili per facilitare il trasporto e la sfoderabilità.
 Montaggio degli elementi con sistema a baionetta. Struttura: agglomerato di legno foderato con tessuto vellutino termoaccoppiato ad un sottile strato di poliuretano espanso. Imbottitura: schienali e sedute in poliuretano espanso indeformabile avvolte con falda siliconata.

Sofa bed with electrowelded bed case, elastic belts and mattress H 13 cm.
 Fully removable covers for fabric upholstery.
 Composed by disassembled pieces for an easy transportation or cover removal.
 Assembly of pieces by metal sliding-rail brackets. Structure: wooden agglomerate lined with fine velvet fabric thermocoupled to a thin layer of polyurethane foam.
 Filling: back and seat cushions in indeformable polyurethane foam, silicone coated.

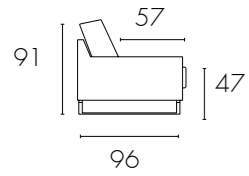

Dimensione con braccioli tipo / Size with armrests type

A

	3 posti max fisso 3,5 places fix		3 posti max letto 3,5 places bed Materasso cm 160 x 197 Mattress cm 160 x 197	230
	3 posti fisso 3 places fix		3 posti letto 3 places bed Materasso cm 140 x 197 Mattress cm 140 x 197	210
	Intermedio fisso 2,5 places fix		Intermedio letto 2,5 places bed Materasso cm 120 x 197 Mattress cm 120 x 197	190
	2 posti fisso 2 places fix		2 posti letto 2 places bed Materasso cm 100 x 197 Mattress cm 100 x 197	170
	Poltrona fisso Armchair fix		Poltrona letto Armchair bed Materasso cm 70 x 197 Mattress cm 70 x 197	140
	3 posti max laterale fisso - bracciolo DX o SX 3,5 lateral places - armrest DX o SX		3 posti max laterale letto - bracciolo DX o SX 3,5 lateral places bed - armrest DX o SX	207
	3 posti laterale fisso - bracciolo DX o SX 3 lateral places fix - armrest DX o SX		3 posti laterale letto - bracciolo DX o SX 3 lateral places bed - armrest DX o SX	187
	Intermedio laterale fisso - bracciolo DX o SX 2,5 lateral places fix - armrest right or left		Intermedio letto - bracciolo DX o SX 2,5 lateral places bed - armrest DX o SX	167



A

23 cm



Dimensione con braccioli tipo / Size with armrests type

A

	2 posti laterale fisso - bracciolo DX o SX 2 lateral places fix - armrest DX o SX		2 posti laterale letto - bracciolo DX o SX 2 lateral places bed - armrest DX o SX	147
	Poltrona laterale fisso - bracciolo DX o SX Armchair lateral fix - armrest DX o SX		Poltrona laterale letto - bracciolo DX o SX Armchair lateral bed - armrest DX o SX	117
	Chaiselongue laterale fissa/apribile bracciolo DX o SX Lateral fixed/storaged chaiselongue armrest DX o SX			106
	Chaiselongue laterale fissa/apribile bracciolo DX o SX Lateral fixed/storaged chaiselongue armrest DX o SX			106
	Pouff fisso/contenitore Fixed/storaged pouf			



Disponibile con piedini /
available with feet /

THOR



101
THOR /
3P BED +
ARMCHAIR BED

Coniuga bellezza,
funzionalità e comfort.

The perfect coniugation of beauty,
functionality and comfort.



102
THOR /
SOFA BED

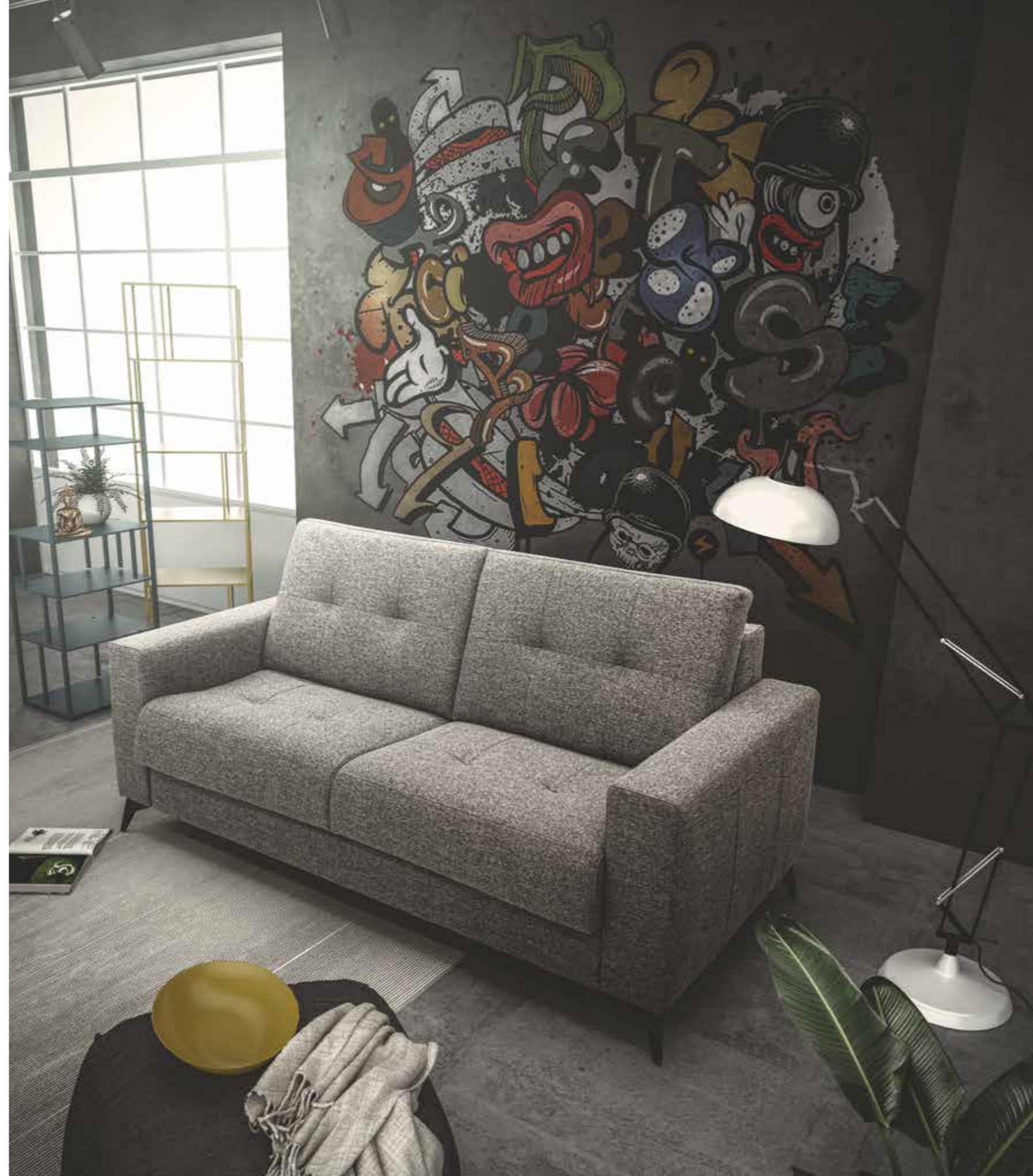



La perfetta sinergia tra lo stile classico e le linee moderne.

The perfect synergy between classical and modern lines.

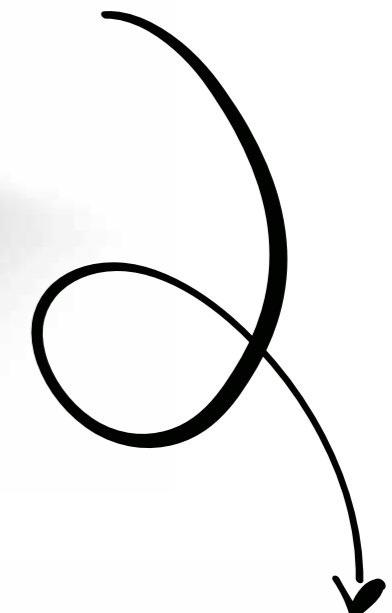
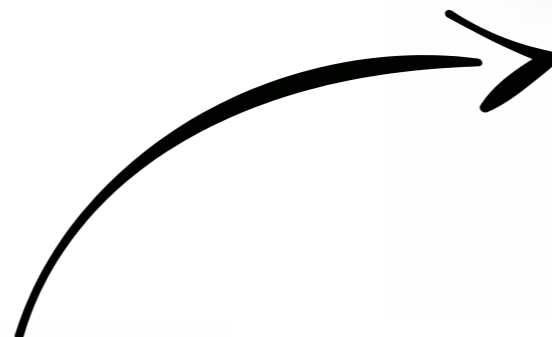
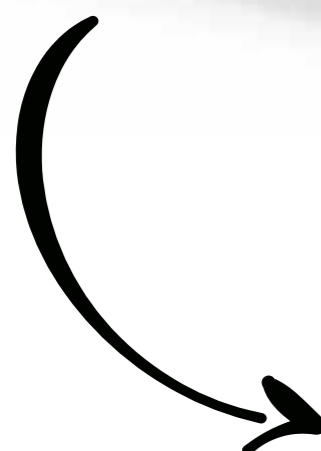

Le ampie sedute e i soffici schienali assicurano il massimo comfort.

The large seats and the soft backrest ensure the best comfort.



104
THOR /
SOFA BED



106
THOR /
SOFA BED



Dalla forte personalità anche nella
versione letto.

With a strong personality even
in the bed version.

Divano letto con rete elettrosaldata e cinghie elastiche, materasso H 13 cm.
 Non sfoderabile. Composto da elementi smontabili per facilitare il trasporto.
 Montaggio degli elementi con sistema a baionetta. Struttura: agglomerato di legno
 foderato con tessuto vellutino termoaccoppiato ad un sottile strato di poliuretano
 espanso. Imbottitura: schienali e sedute in poliuretano
 espanso indeformabile avvolte con falda siliconata.

Sofa bed with electrowelded bed case, elastic belts and mattress H 13 cm.
 Fabric not removable. Composed by disassembled pieces for an easy transportation.
 Assembly of pieces by metal sliding-rail brackets. Structure: wooden agglomerate
 lined with fine velvet fabric thermocoupled to a thin layer of polyurethane foam.
 Filling: back and seat cushions in indeformable polyurethane foam, silicone coated.

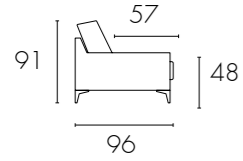

Dimensione con braccioli tipo / Size with armrests type

				A	B
	3 posti max fisso 3,5 places fix		3 posti max letto 3,5 places bed Materasso cm 160 x 197 Mattress cm 160 x 197	232	224
	3 posti fisso 3 places fix		3 posti letto 3 places bed Materasso cm 140 x 197 Mattress cm 140 x 197	212	204
	Intermedio fisso 2,5 places fix		Intermedio letto 2,5 places bed Materasso cm 120 x 197 Mattress cm 120 x 197	192	184
	2 posti fisso 2 places fix		2 posti letto 2 places bed Materasso cm 100 x 197 Mattress cm 100 x 197	172	164
	Poltrona fisso Armchair fix		Poltrona letto Armchair bed Materasso cm 70 x 197 Mattress cm 70 x 197	142	134
	3 posti max laterale fisso - bracciolo DX o SX 3,5 lateral places - armrest DX o SX		3 posti max laterale letto - bracciolo DX o SX 3,5 lateral places bed - armrest DX o SX	208	204
	3 posti laterale fisso - bracciolo DX o SX 3 lateral places fix - armrest DX o SX		3 posti laterale letto - bracciolo DX o SX 3 lateral places bed - armrest DX o SX	188	184
	Intermedio laterale fisso - bracciolo DX o SX 2,5 lateral places fix - armrest right or left		Intermedio letto - bracciolo DX o SX 2,5 lateral places bed - armrest DX o SX	168	164



Dimensione con braccioli tipo / Size with armrests type

				A	B
	2 posti laterale fisso - bracciolo DX o SX 2 lateral places fix - armrest DX o SX		2 posti laterale letto - bracciolo DX o SX 2 lateral places bed - armrest DX o SX	148	144
	Poltrona laterale letto - bracciolo DX o SX Armchair lateral bed - armrest DX o SX			118	114
	Poltrona laterale fisso - bracciolo DX o SX Armchair lateral fix - armrest DX o SX			88	84
	Chaiselongue laterale fissa/apribile bracciolo DX o SX Lateral fixed/storaged chaiselongue armrest DX o SX			106	102
	Chaiselongue laterale fissa/apribile bracciolo DX o SX Lateral fixed/storaged chaiselongue armrest DX o SX			106	102
	Pouff fisso/contenitore Fixed/storaged pouf				

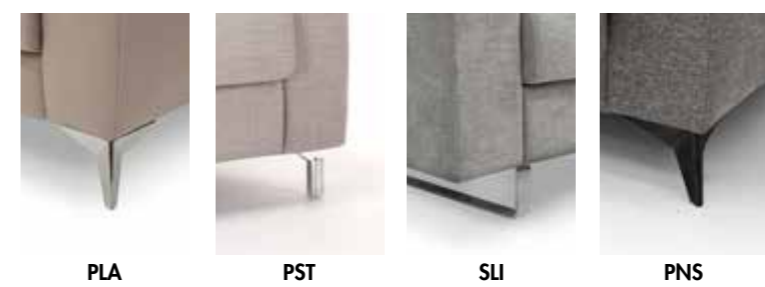

Disponibile con piedini /
available with feet /



NIZZA

111
NIZZA /
SOFA BED

La precisione delle finiture artigianali
contribuisce a creare
un prodotto di assoluta qualità.

The precise craftsmanlike finishing
helps make soul
a product of the highest quality.



112
NIZZA /
SOFA BED



113
NIZZA /
SOFA BED



114
NIZZA /
SOFA BED



Unico nel suo genere,
unisce qualità e comfort.
Unique in his category, combine
quality and comfort.

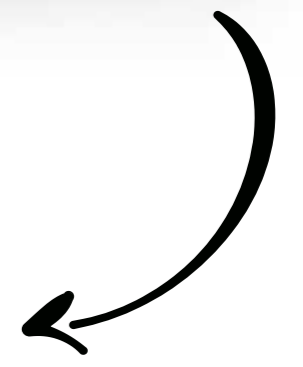
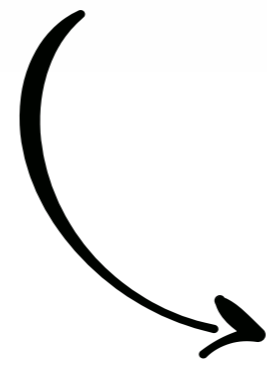



117
NIZZA /
SOFA BED

Divano letto con rete elettrosaldata e cinghie elastiche, materasso H 13 cm (materasso H 18 cm con opzione). Composto da elementi smontabili per facilitare il trasporto. Montaggio degli elementi con sistema a baionetta. Struttura: agglomerato di legno foderato con tessuto vellutino termoaccoppiato ad un sottile strato di poliuretano espanso. Imbottitura: schienali e sedute in poliuretano espanso indeformabile avvolte con falda siliconata.

Sofa bed with electrowelded bed case, elastic belts and mattress H 13 cm (mattress H 18 cm with option). Composed by disassembled pieces for an easy transportation. Assembly of pieces by metal sliding-rail brackets. Structure: wooden agglomerate lined with fine velvet fabric thermocoupled to a thin layer of polyurethane foam. Filling: back and seat cushions in indeformable polyurethane foam, silicone coated.

**MATERASSO H 18 CM CON OPZIONE
MATTRESS H 18 CM WITH OPTION**

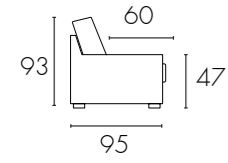

Dimensione con braccioli tipo / Size with armrests type

			A	B	C	
	3 posti max fisso 3,5 places fix		3 posti max letto 3,5 places bed Materasso cm 160 x 197 Mattress cm 160 x 197	232	224	214
	3 posti fisso 3 places fix		3 posti letto 3 places bed Materasso cm 140 x 197 Mattress cm 140 x 197	212	204	194
	3 posti max laterale fisso - bracciolo DX o SX 3,5 lateral places - armrest DX o SX		3 posti max laterale letto - bracciolo DX o SX 3,5 lateral places bed - armrest DX o SX	208	204	199
	3 posti laterale fisso - bracciolo DX o SX 3 lateral places fix - armrest DX o SX		3 posti laterale letto - bracciolo DX o SX 3 lateral places bed - armrest DX o SX	188	184	179



Dimensione con braccioli tipo / Size with armrests type

			A	B	C
	Chaiselongue laterale fissa/apribile bracciolo DX o SX Lateral fixed/storaged chaiselongue armrest DX o SX		107	103	98
	Chaiselongue laterale fissa/apribile bracciolo DX o SX Lateral fixed/storaged chaiselongue armrest DX o SX		107	103	98
	Pouff fisso/contenitore Fixed/storaged pouf				



Disponibile con piedini /
available with feet /

DUBAI



121
DUBAI /
SOFA BED



Unico nel suo genere,
unisce qualità e comfort.

Unique in his category,
combine quality and comfort.



122
DUBAI / 3P
SOFA BED





Quando il dinamismo
diventa design.

When dynamism
turns into design.

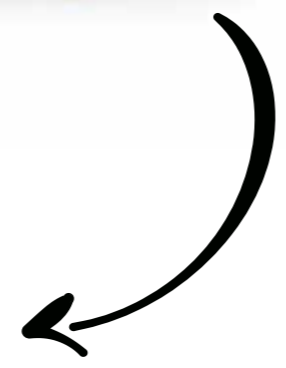
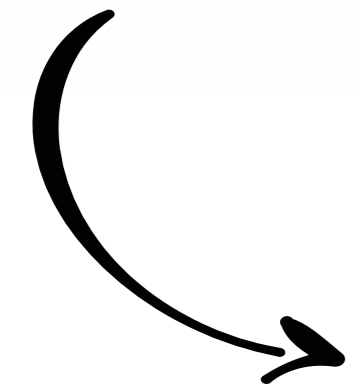

Il comfort è garantito dai generosi
braccioli e dai poggiatesta reclinabili.

The comfort is guaranteed by the
generous arms and the adjustable
headrest.



125
DUBAI /
SOFA BED

Monocromatico o bicolore
per renderlo unico e personale.

Monochrome or two-tone
to make it unique and personal.



126
DUBAI /
EXAMPLES OF COLORS

Nella variante bicolore,
Dubai perde la sua allure classica
mostrando una natura post moderna.

In the bicolour variants,
Dubai loses its classical allure,
showing a post-modern nature.

Divano letto con rete elettrosaldata e cinghie elastiche, materasso H 13 cm (materasso H 18 cm con opzione). Completamente sfoderabile con rivestimento in tessuto. Composto da elementi smontabili per facilitare il trasporto e la sfoderabilità. Montaggio degli elementi con sistema a baionetta. Struttura: agglomerato di legno foderato con tessuto vellutino termocoppato ad un sottile strato di poliuretano espanso. Imbottitura: schienali e sedute in poliuretano espanso indeformabile avvolte con falda siliconata. Vano porta guanciali su retro schienale.

Sofa bed with electrowelded bed case, elastic belts and mattress H 13 cm (mattress H 18 cm with option). Fully removable covers for fabric upholstery. Composed by disassembled pieces for an easy transportation or cover removal. Assembly of pieces by metal sliding-rail brackets. Structure: wooden agglomerate lined with fine velvet fabric thermocoupled to a thin layer of polyurethane foam. Filling: back and seat cushions in indeformable polyurethane foam, silicone coated. Pillow compartment on sofa back.



**MATERASSO H 18 CM CON OPZIONE
MATTRESS H 18 CM WITH OPTION**

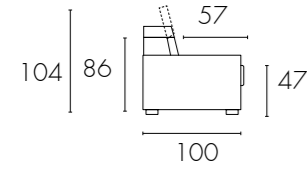

Dimensione con braccioli tipo / Size with armrests type

Dimensione con braccioli tipo / Size with armrests type		A
	3 posti max fisso 3,5 places fix	3 posti max letto 3,5 places bed Materasso cm 160 x 197 Mattress cm 160 x 197
	3 posti fisso 3 places fix	3 posti letto 3 places bed Materasso cm 140 x 197 Mattress cm 140 x 197
	Intermedio fisso 2,5 places fix	Intermedio letto 2,5 places bed Materasso cm 120 x 197 Mattress cm 120 x 197
	2 posti fisso 2 places fix	2 posti letto 2 places bed Materasso cm 100 x 197 Mattress cm 100 x 197
	3 posti max laterale fisso - bracciolo DX o SX 3,5 lateral places - armrest DX o SX	3 posti max laterale letto - bracciolo DX o SX 3,5 lateral places bed - armrest DX o SX
	3 posti laterale fisso - bracciolo DX o SX 3 lateral places fix - armrest DX o SX	3 posti laterale letto - bracciolo DX o SX 3 lateral places bed - armrest DX o SX
	Intermedio laterale fisso - bracciolo DX o SX 2,5 lateral places fix - armrest right or left	Intermedio letto - bracciolo DX o SX 2,5 lateral places bed - armrest DX o SX

Dimensione con braccioli tipo / Size with armrests type

Dimensione con braccioli tipo / Size with armrests type		A
	2 posti laterale fisso - bracciolo DX o SX 2 lateral places fix - armrest DX o SX	2 posti laterale letto - bracciolo DX o SX 2 lateral places bed - armrest DX o SX
	Chaiselongue laterale fissa/apribile bracciolo DX o SX Lateral fixed/stored chaiselongue armrest DX o SX	
	Chaiselongue laterale fissa/apribile bracciolo DX o SX Lateral fixed/stored chaiselongue armrest DX o SX	
	Pouff fisso/contenitore Fixed/stored pouff	



Disponibile con piedini / available with feet /

DAKAR



131
DAKAR /
SOFA BED

La sua linea moderna
è arricchita da una bordatura
che disegna ed esalta
i profili morbidi del divano.

Its modern style is enhanced
by a border with designs and
exalts the sofa soft profiles.



132
DAKAR /
SOFA BED





134
DAKAR /
SOFA BED

Personalità per spazi
confortevoli.

Exceptional character,
exceptional comfort.

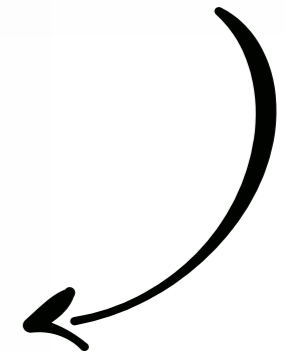
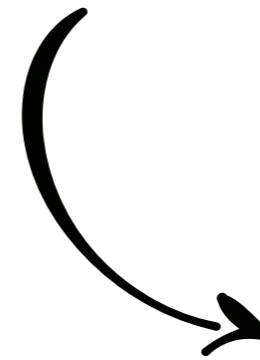

137
DAKAR /
SOFA BED

Divano letto con rete elettrosaldata e cinghie elastiche, materasso H 13 cm (materasso H 18 cm con opzione). Completamente sfoderabile con rivestimento in tessuto. Composto da elementi smontabili per facilitare il trasporto e la sfoderabilità. Montaggio degli elementi con sistema a baionetta. Struttura: agglomerato di legno foderato con tessuto vellutino termocoppiato ad un sottile strato di poliuretano espanso. Imbottitura: cuscini schienali in fiocco di fibra di poliestere 200g/m³ e sedute in poliuretano espanso indeformabile avvolte con falda siliconata.

Sofa bed with electrowelded bed case, elastic belts and mattress H 13 cm (mattress H 18 cm with option). Fully removable covers for fabric upholstery. Composed by disassembled pieces for an easy transportation or cover removal. Assembly of pieces by metal sliding-rail brackets. Structure: wooden agglomerate lined with fine velvet fabric thermocoupled to a thin layer of polyurethane foam. Filling: backrest cushions made of polyester fiber flakes 200 g/m³ and seat cushions in indeformable polyurethane foam, silicone coated.

**MATERASSO H 18 CM CON OPZIONE
MATTRESS H 18 CM WITH OPTION**

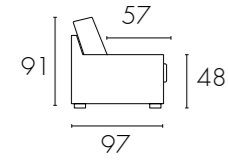

Dimensione con braccioli tipo / Size with armrests type

			A	B	C	D
	3 posti max fisso 3,5 places fix	 Materasso cm 160 x 197 Mattress cm 160 x 197	229	221	211	201
	3 posti fisso 3 places fix	 Materasso cm 140 x 197 Mattress cm 140 x 197	209	201	191	181
	Intermedio fisso 2,5 places fix	 Materasso cm 120 x 197 Mattress cm 120 x 197	189	181	171	161
	2 posti fisso 2 places fix	 Materasso cm 100 x 197 Mattress cm 100 x 197	169	161	151	141
	Poltrona letto Armchair bed	 Materasso cm 70 x 197 Mattress cm 70 x 197	139	131	121	111
	Poltrona fissa Armchair fix		109	101	91	81
	3 posti max laterale fisso - bracciolo DX o SX 3,5 lateral places - armrest DX o SX		207	203	198	193
	3 posti laterale fisso - bracciolo DX o SX 3 lateral places fix - armrest DX o SX		187	183	178	173
	Intermedio laterale fisso - bracciolo DX o SX 2,5 lateral places fix - armrest right or left		167	163	158	153



Dimensione con braccioli tipo / Size with armrests type

			A	B	C	D
	2 posti laterale fisso - bracciolo DX o SX 2 lateral places fix - armrest DX o SX		147	143	138	133
	Poltrona laterale letto - bracciolo DX o SX Armchair lateral bed - armrest DX o SX		117	113	108	103
	Poltrona laterale fisso - bracciolo DX o SX Armchair lateral fix - armrest DX o SX		87	83	78	73
	Chaiselongue laterale fissa/apribile bracciolo DX o SX Lateral fixed/storaged chaiselongue armrest DX o SX		104	100	95	90
	Chaiselongue laterale fissa/apribile bracciolo DX o SX Lateral fixed/storaged chaiselongue armrest DX o SX		104	100	95	90
	Pouff fisso/contentitore Fixed/storaged pouf					
	Disponibile con piedini / available with feet /					

MABEL



141
MABEL /
SOFA BED



143

MABEL /
3P FIX +
3P SOFA BED



Un carattere deciso capace di esaltarsi attraverso il perfezionamento dei particolari.

A strong character brought out in carefully selected details.



145
MABEL /
SOFA BED



146
MABEL /
SOFA BED

Divano letto con rete elettrosaldata e cinghie elastiche, materasso H 13 cm (materasso H 18 cm con opzione). Completamente sfoderabile con rivestimento in tessuto. Composto da elementi smontabili per facilitare il trasporto e la sfoderabilità. Montaggio degli elementi con sistema a baionetta. Struttura: agglomerato di legno foderato con tessuto vellutino termoaccoppiato ad un sottile strato di poliuretano espanso. Imbottitura: cuscini schienali in fiocco di fibra di poliestere 200g/m³ e sedute in poliuretano espanso indeformabile avvolte con falda siliconata.

Sofa bed with electrowelded bed case, elastic belts and mattress H 13 cm (mattress H 18 cm with option). Fully removable covers for fabric upholstery. Composed by disassembled pieces for an easy transportation or cover removal. Assembly of pieces by metal sliding-rail brackets. Structure: wooden agglomerate lined with fine velvet fabric thermocoupled to a thin layer of polyurethane foam. Filling: backrest cushions made of polyester fiber flakes 200 g/m³ and seat cushions in indeformable polyurethane foam, silicone coated.

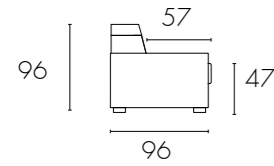

**MATERASSO H 18 CM CON OPZIONE
MATTRESS H 18 CM WITH OPTION**

Dimensione con braccioli tipo / Size with armrests type

A

	3 posti max fisso 3,5 places fix		3 posti max letto 3,5 places bed Materasso cm 160 x 197 Mattress cm 160 x 197	225
	3 posti fisso 3 places fix		3 posti letto 3 places bed Materasso cm 140 x 197 Mattress cm 140 x 197	205
	Intermedio fisso 2,5 places fix		Intermedio letto 2,5 places bed Materasso cm 120 x 197 Mattress cm 120 x 197	185
	2 posti fisso 2 places fix		2 posti letto 2 places bed Materasso cm 100 x 197 Mattress cm 100 x 197	165
	Poltrona letto Armchair bed		Materasso cm 70 x 197 Mattress cm 70 x 197	135
	Poltrona fissa Armchair fix			105
	3 posti max laterale fisso - bracciolo DX o SX 3,5 lateral places - armrest DX o SX		3 posti max laterale letto - bracciolo DX o SX 3,5 lateral places bed - armrest DX o SX	204
	3 posti laterale fisso - bracciolo DX o SX 3 lateral places fix - armrest DX o SX		3 posti laterale letto - bracciolo DX o SX 3 lateral places bed - armrest DX o SX	184
	Intermedio laterale fisso - bracciolo DX o SX 2,5 lateral places fix - armrest right or left		Intermedio letto - bracciolo DX o SX 2,5 lateral places bed - armrest DX o SX	164



A
21 cm



Dimensione con braccioli tipo / Size with armrests type

A

	2 posti laterale fisso - bracciolo DX o SX 2 lateral places fix - armrest DX o SX		2 posti laterale letto - bracciolo DX o SX 2 lateral places bed - armrest DX o SX	144
	Poltrona laterale letto - bracciolo DX o SX Armchair lateral bed - armrest DX o SX			114
	Poltrona laterale fisso - bracciolo DX o SX Armchair lateral fix - armrest DX o SX			84
	Chaiselongue laterale fissa/apribile bracciolo DX o SX Lateral fixed/stored chaiselongue armrest DX o SX			103
	Chaiselongue laterale fissa/apribile bracciolo DX o SX Lateral fixed/stored chaiselongue armrest DX o SX			103
	Pouff fisso/contenitore Fixed/stored pouff			



Disponibile con piedini /
available with feet /

STEP



150
STEP /
SOFA BED

Step è un divano letto
imbottito, dalla linea
pulita e morbida.

Step is an upholstered sofa
bed, designed with a clean,
soft form.



152
STEP /
SOFA BED



153
STEP /
SOFA BED



Arricchisce di stile sia le
ambientazioni
classiche che quelle moderne.

It enriched
modern and classic environments.



155
STEP /
SOFA BED

Divano letto con rete elettrosaldata e cinghie elastiche, materasso H 13 cm.
 Completamente sfoderabile con rivestimento in tessuto. Composto da elementi smontabili per facilitare il trasporto e la sfoderabilità.
 Montaggio degli elementi con sistema a baionetta. Struttura: agglomerato di legno foderato con tessuto vellutino termoaccoppiato ad un sottile strato di poliuretano espanso. Imbottitura: schienali e sedute in poliuretano espanso indeformabile avvolte con falda siliconata.
 Vano porta guanciali su retro schienale.

Sofa bed with electrowelded bed case, elastic belts and mattress H 13 cm.
 Fully removable covers for fabric upholstery.
 Composed by disassembled pieces for an easy transportation or cover removal.
 Assembly of pieces by metal sliding-rail brackets. Structure: wooden agglomerate lined with fine velvet fabric thermocoupled to a thin layer of polyurethane foam.
 Filling: back and seat cushions in indeformable polyurethane foam, silicone coated.
 Pillow compartment on sofa back.

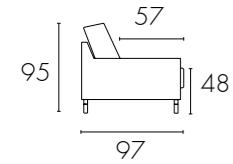

Dimensione con braccioli tipo / Size with armrests type			A	B
	3 posti max fisso 3,5 places fix	 Materasso cm 160 x 197 Mattress cm 160 x 197	231	223
	3 posti fisso 3 places fix	 Materasso cm 140 x 197 Mattress cm 140 x 197	211	203
	Intermedio fisso 2,5 places fix	 Materasso cm 120 x 197 Mattress cm 120 x 197	191	183
	2 posti fisso 2 places fix	 Materasso cm 100 x 197 Mattress cm 100 x 197	171	163
	Poltrona letto Armchair bed	 Materasso cm 70 x 197 Mattress cm 70 x 197	141	133
	Poltrona fissa Armchair fix		111	103
	3 posti max laterale fisso - bracciolo DX o SX 3,5 lateral places - armrest DX o SX		208	204
	3 posti laterale fisso - bracciolo DX o SX 3 lateral places fix - armrest DX o SX		188	184
	Intermedio laterale fisso - bracciolo DX o SX 2,5 lateral places fix - armrest right or left		168	164

Dimensione con braccioli tipo / Size with armrests type			A	B
	2 posti laterale fisso - bracciolo DX o SX 2 lateral places fix - armrest DX o SX		148	144
	Poltrona laterale letto - bracciolo DX o SX Armchair lateral bed - armrest DX o SX		118	114
	Poltrona laterale fisso - bracciolo DX o SX Armchair lateral fix - armrest DX o SX		88	84
	Chaiselongue laterale fissa/apribile bracciolo DX o SX Lateral fixed/stored chaiselongue armrest DX o SX		105	101
	Chaiselongue laterale fissa/apribile bracciolo DX o SX Lateral fixed/stored chaiselongue armrest DX o SX		105	101
	Pouff fisso/contenitore Fixed/stored pouff			

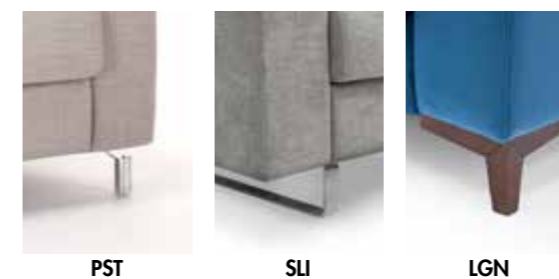

Disponibile con piedini /
available with feet /

ELOISE



158
ELOISE /
SOFA BED

Dal design ricercato, le comode sedute ed i poggiatesta reclinabili assicurano grande comfort.

Sophisticated design, the comfortable seating/seat and reclining headrest ensure great comfort.



160
ELOISE /
SOFA BED

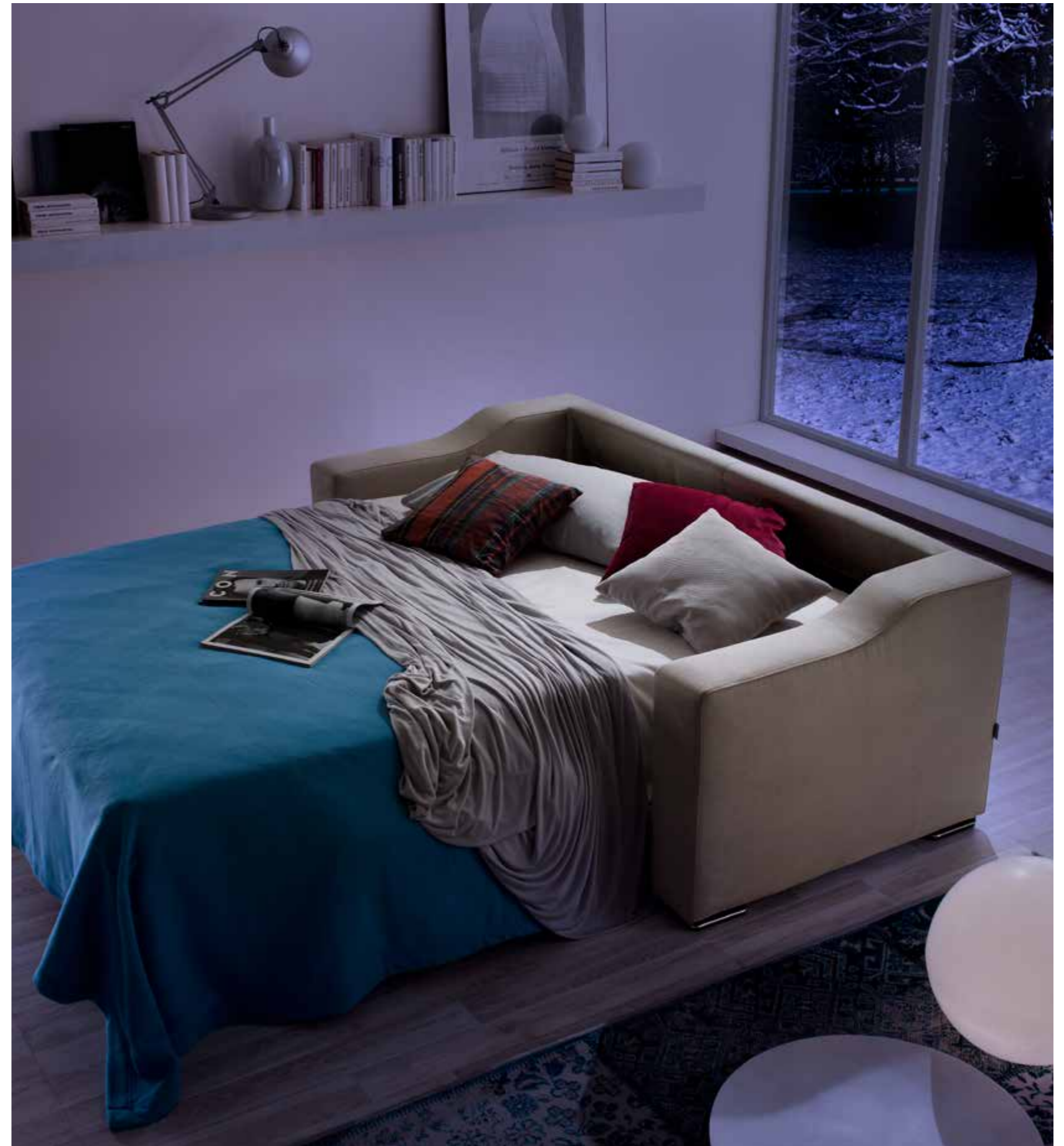



Eloise è una famiglia di imbottiti dove lo spazio prende una nuova forma, con il morbido schienale e i poggiatesta reclinabili.

Eloise is a family of upholstered furniture when the space has a new shape with the soft backrest and reclining headrest.

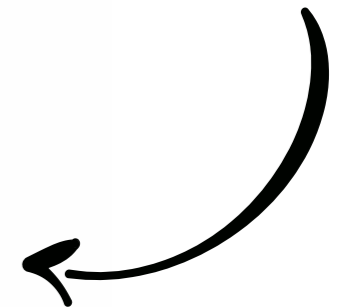
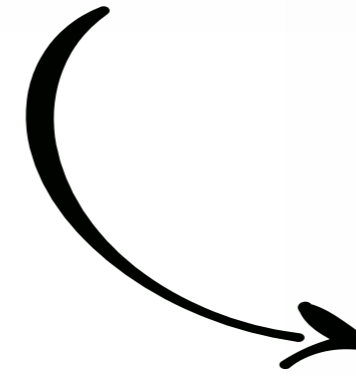

163
ELOISE /
SOFA BED

Divano letto con rete elettrosaldata e cinghie elastiche, materasso H 13 cm (materasso H 18 cm con opzione). Completamente sfoderabile con rivestimento in tessuto. Composto da elementi smontabili per facilitare il trasporto e la sfoderabilità. Montaggio degli elementi con sistema a baionetta. Struttura: agglomerato di legno foderato con tessuto vellutino termoaccoppiato ad un sottile strato di poliuretano espanso. Imbottitura: schienali e sedute in poliuretano espanso indeformabile avvolte con falda siliconata. Vano porta guanciali su retro schienale.



Sofa bed with electrowelded bed case, elastic belts and mattress H 13 cm (mattress H 18 cm with option). Fully removable covers for fabric upholstery. Composed by disassembled pieces for an easy transportation or cover removal. Assembly of pieces by metal sliding-rail brackets. Structure: wooden agglomerate lined with fine velvet fabric thermocoupled to a thin layer of polyurethane foam. Filling: back and seat cushions in indeformable polyurethane foam, silicone coated. Pillow compartment on sofa back.



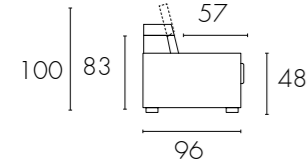



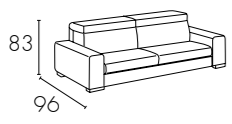
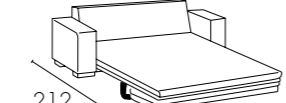
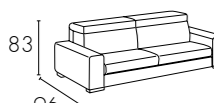
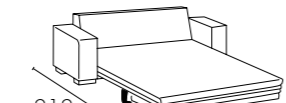
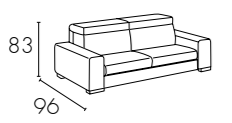
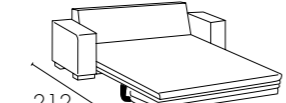
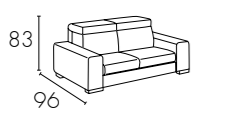
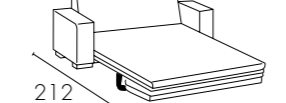

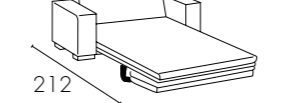
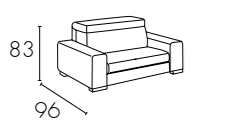
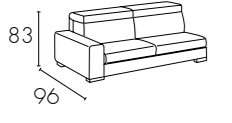
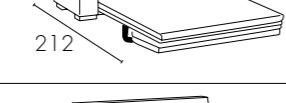
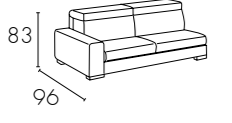
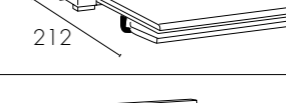
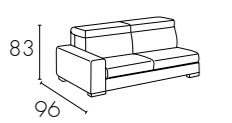
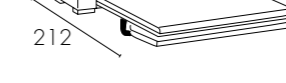

**MATERASSO H 18 CM CON OPZIONE
MATTRESS H 18 CM WITH OPTION**

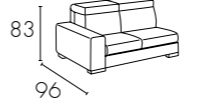
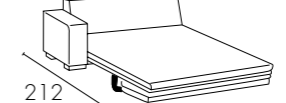

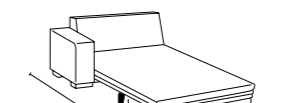
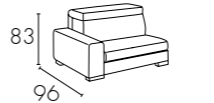
Dimensione con braccioli tipo / Size with armrests type

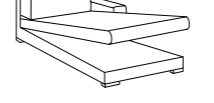
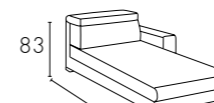
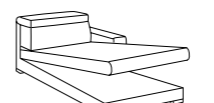
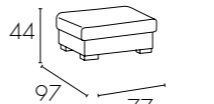
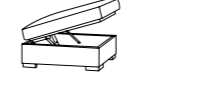
				A	B	C
	3 posti max fisso 3,5 places fix		3 posti max letto 3,5 places bed Materasso cm 160 x 197 Mattress cm 160 x 197	229	221	211
	3 posti fisso 3 places fix		3 posti letto 3 places bed Materasso cm 140 x 197 Mattress cm 140 x 197	209	201	191
	Intermedio fisso 2,5 places fix		Intermedio letto 2,5 places bed Materasso cm 120 x 197 Mattress cm 120 x 197	189	181	171
	2 posti fisso 2 places fix		2 posti letto 2 places bed Materasso cm 100 x 197 Mattress cm 100 x 197	169	161	151
			Poltrona letto Armchair bed Materasso cm 70 x 197 Mattress cm 70 x 197	139	131	121
	Poltrona fissa Armchair fix			109	101	91
	3 posti max laterale fisso - bracciolo DX o SX 3,5 lateral places - armrest DX o SX		3 posti max laterale letto - bracciolo DX o SX 3,5 lateral places bed - armrest DX o SX	206	202	197
	3 posti laterale fisso - bracciolo DX o SX 3 lateral places fix - armrest DX o SX		3 posti laterale letto - bracciolo DX o SX 3 lateral places bed - armrest DX o SX	186	182	177
	Intermedio laterale fisso - bracciolo DX o SX 2,5 lateral places fix - armrest right or left		Intermedio letto - bracciolo DX o SX 2,5 lateral places bed - armrest DX o SX	166	162	157

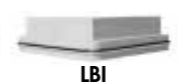
Dimensione con braccioli tipo / Size with armrests type

				A	B	C
	2 posti laterale fisso - bracciolo DX o SX 2 lateral places fix - armrest DX o SX		2 posti laterale letto - bracciolo DX o SX 2 lateral places bed - armrest DX o SX	146	142	137
			Poltrona laterale letto - bracciolo DX o SX Armchair lateral bed - armrest DX o SX	116	112	107
	Poltrona laterale fisso - bracciolo DX o SX Armchair lateral fix - armrest DX o SX			86	82	77
			Chaiselongue laterale fissa/apribile bracciolo DX o SX Lateral fixed/storaged chaiselongue armrest DX o SX	109	105	100
			Chaiselongue laterale fissa/apribile bracciolo DX o SX Lateral fixed/storaged chaiselongue armrest DX o SX	109	105	100
			Pouff fisso/contenitore Fixed/storaged pouf			
				Disponibile con piedini / available with feet /		
LWE	LCI	LBI	LAL			

STILOS



167
STILOS /
SOFA BED

Dal design ricercato, le comode sedute ed i poggiatesta reclinabili assicurano grande comfort.

Sophisticated design, the comfortable seating/seat and reclining headrest ensure great comfort.



168
STILOSIO /
SOFA BED





170
STILOSIO /
SOFA BED



172
STILOSÒ /
3P FIX +
3P MAX BED

173
STILOSÒ /
3P FIX +
3P MAX BED

Divano letto con rete elettrosaldata e cinghie elastiche, materasso H 13 cm.
 Completamente sfoderabile con rivestimento in tessuto. Composto da elementi smontabili per facilitare il trasporto e la sfoderabilità.
 Montaggio degli elementi con sistema a baionetta. Struttura: agglomerato di legno foderato con tessuto vellutino termoaccoppiato ad un sottile strato di poliuretano espanso. Imbottitura: schienali e sedute in poliuretano espanso indeformabile avvolte con falda siliconata.
 Vano porta guanciali su retro schienale.

Sofa bed with electrowelded bed case, elastic belts and mattress H 13 cm.
 Fully removable covers for fabric upholstery.
 Composed by disassembled pieces for an easy transportation or cover removal.
 Assembly of pieces by metal sliding-rail brackets. Structure: wooden agglomerate lined with fine velvet fabric thermocoupled to a thin layer of polyurethane foam.
 Filling: back and seat cushions in indeformable polyurethane foam, silicone coated.
 Pillow compartment on sofa back.

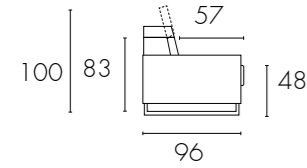

Dimensione con braccioli tipo / Size with armrests type

			A	B	C
	3 posti max fisso 3,5 places fix				
			229	221	211
	3 posti fisso 3 places fix				
			209	201	191
	Intermedio fisso 2,5 places fix				
			189	181	171
	2 posti fisso 2 places fix				
			169	161	151
	Poltrona fisso Armchair fix				
			139	131	121
	3 posti max laterale fisso - bracciolo DX o SX 3,5 lateral places fix - armrest DX o SX				
			206	202	197
	3 posti laterale fisso - bracciolo DX o SX 3 lateral places fix - armrest DX o SX				
			186	182	177
	Intermedio laterale fisso - bracciolo DX o SX 2,5 lateral places fix - armrest right or left				
			166	162	157



Dimensione con braccioli tipo / Size with armrests type

			A	B	C
	2 posti laterale fisso - bracciolo DX o SX 2 lateral places fix - armrest DX o SX				
			146	142	137
	Poltrona laterale fisso - bracciolo DX o SX Armchair lateral fix - armrest DX o SX				
			116	112	107
	Poltrona laterale fisso - bracciolo DX o SX Armchair lateral fix - armrest DX o SX				
			86	82	77
	Chaiselongue laterale fissa/apribile bracciolo DX o SX Lateral fixed/storaged chaiselongue armrest DX o SX				
			109	105	100
	Chaiselongue laterale fissa/apribile bracciolo DX o SX Lateral fixed/storaged chaiselongue armrest DX o SX				
			109	105	100
	Pouff fisso/contenitore Fixed/storaged pouf				

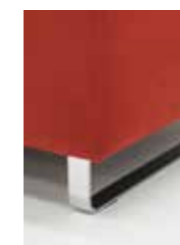

Disponibile con piedini /
available with feet /

LOIS



177

LOIS /
SOFA BED

Lois associa al design la morbidezza di raffinati dettagli sartoriali.

Lois mixes design with the softness of refined sartorial details.



178
LOIS / B SOFA BED
LOIS / E SOFA BED



Importante
nella presenza e cura dei dettagli.

Important
in the presence and
attentive to the details.



180
LOIS /
SOFA BED



Divano letto con rete elettrosaldata e cinghie elastiche, materasso H 13 cm (materasso H 18 cm con opzione). Non sfoderabile. Composto da elementi smontabili per facilitare il trasporto. Montaggio degli elementi con sistema a baionetta. Struttura: agglomerato di legno foderato con tessuto vellutino termoaccoppiato ad un sottile strato di poliuretano espanso. Imbottitura: cuscini schienali in fiocco di fibra di poliestere 200g/m3 e sedute in poliuretano espanso indeformabile avvolte con falda siliconata.

Sofa bed with electrowelded bed case, elastic belts and mattress H 13 cm (mattress H 18 cm with option). Fabric not removable. Composed by disassembled pieces for an easy transportation. Assembly of pieces by metal sliding-rail brackets. Structure: wooden agglomerate lined with fine velvet fabric thermocoupled to a thin layer of polyurethane foam. Filling: backrest cushions made of polyester fiber flakes 200 g/m3 and seat cushions in indeformable polyurethane foam, silicone coated.

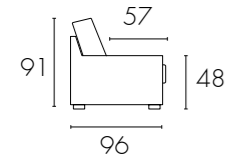

**MATERASSO H 18 CM CON OPZIONE
MATTRESS H 18 CM WITH OPTION**

Dimensione con braccioli tipo / Size with armrests type

			A	B	C	D	E
	3 posti max fisso 3,5 places fix		232	224	214	204	225
	3 posti fisso 3 places fix		212	204	194	184	205
	Intermedio fisso 2,5 places fix		192	184	174	164	185
	2 posti fisso 2 places fix		172	164	154	144	165
	Poltrona fisso Armchair fix		142	134	124	114	135
	3 posti max laterale fisso - bracciolo DX o SX 3,5 lateral places - armrest DX o SX		208	204	199	194	205
	3 posti laterale fisso - bracciolo DX o SX 3 lateral places fix - armrest DX o SX		188	184	179	174	185
	Intermedio laterale fisso - bracciolo DX o SX 2,5 lateral places fix - armrest right or left		168	164	159	154	165



Dimensione con braccioli tipo / Size with armrests type

			A	B	C	D	E
	2 posti laterale fisso - bracciolo DX o SX 2 lateral places fix - armrest DX o SX		148	144	139	134	145
	Poltrona laterale letto - bracciolo DX o SX Armchair lateral bed - armrest DX o SX		118	114	109	104	115
	Poltrona laterale fisso - bracciolo DX o SX Armchair lateral fix - armrest DX o SX		88	84	79	74	85
	Chaiselongue laterale fissa/apribile bracciolo DX o SX Lateral fixed/storaged chaiselongue armrest DX o SX		106	102	97	92	103
	Chaiselongue laterale fissa/apribile bracciolo DX o SX Lateral fixed/storaged chaiselongue armrest DX o SX		106	102	97	92	103
	Pouff fisso/contenitore Fixed/storaged pouff						



Disponibile con piedini /
available with feet /

SLIDE



185

SLIDE /
SOFA BED

Dalla linea slanciata e
inconfondibile.

Slender and unmistakable line.



186
SLIDE /
SOFA BED





189
SLIDE /
SOFA BED

Divano letto con rete elettrosaldata e cinghie elastiche, materasso H 13 cm.
 Completamente sfoderabile e rivestimento in tessuto. Composto da elementi smontabili per facilitare il trasporto e la sfoderabilità.
 Montaggio degli elementi con sistema a baionetta. Struttura: agglomerato di legno foderato con tessuto vellutino termocoppiato ad un sottile strato di poliuretano espanso. Imbottitura: schienali e sedute in poliuretano espanso indeformabile avvolte con falda siliconata.

Sofa bed with electrowelded bed case, elastic belts and mattress H 13 cm.
 Fully removable covers for fabric upholstery.
 Composed by disassembled pieces for an easy transportation or cover removal.
 Assembly of pieces by metal sliding-rail brackets. Structure: wooden agglomerate lined with fine velvet fabric thermocoupled to a thin layer of polyurethane foam.
 Filling: back and seat cushions in indeformable polyurethane foam, silicone coated.

SLIDE

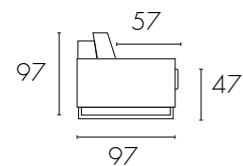

Dimensione con braccioli tipo / Size with armrests type

			A	B	C
	3 posti max fisso 3,5 places fix		212		
	3 posti fisso 3 places fix		212		
	Intermedio fisso 2,5 places fix		212		
	2 posti fisso 2 places fix		212		
	Poltrona fisso Armchair fix		212		
	3 posti max laterale fisso - bracciolo DX o SX 3,5 lateral places - armrest DX o SX		212		
	3 posti laterale fisso - bracciolo DX o SX 3 lateral places fix - armrest DX o SX		212		
	Intermedio laterale fisso - bracciolo DX o SX 2,5 lateral places fix - armrest right or left		212		
			233	225	215
			213	205	195
			193	185	175
			173	165	155
			143	135	125
			113	105	95
			209	205	200
			189	185	180
			169	165	160

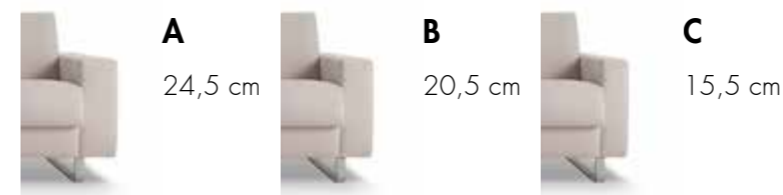

Dimensione con braccioli tipo / Size with armrests type

			A	B	C
	2 posti laterale fisso - bracciolo DX o SX 2 lateral places fix - armrest DX o SX		212		
	Poltrona laterale letto - bracciolo DX o SX Armchair lateral bed - armrest DX o SX		212		
	Poltrona laterale fisso - bracciolo DX o SX Armchair lateral fix - armrest DX o SX				
	Chaiselongue laterale fissa/apribile bracciolo DX o SX Lateral fixed/storaged chaiselongue armrest DX o SX				
	Chaiselongue laterale fissa/apribile bracciolo DX o SX Lateral fixed/storaged chaiselongue armrest DX o SX				
	Pouff fisso/contenitore Fixed/storaged pouf				
			149	145	140
			119	115	110
			89	85	80
			106	102	97
			106	102	97
	Disponibile con piedini / available with feet /				

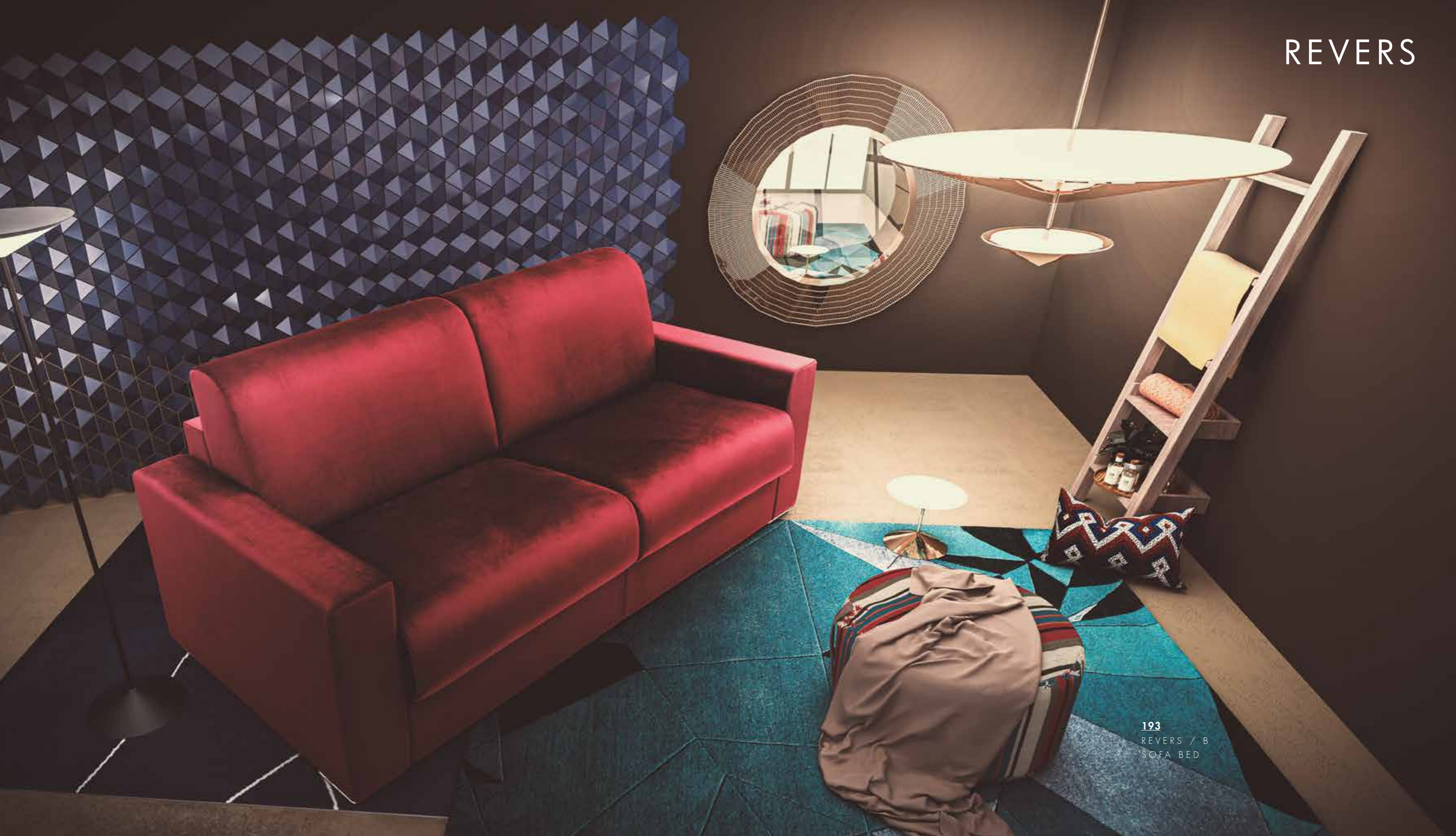

Revers è una famiglia di imbottiti dove ogni elemento identifica un percorso fatto di ricerca.

Revers is a family of upholstered furniture when each element defines a path of research.



194
REVERS / B
+ CIRCLE CHAISÉLONGUE



195
REVERS / B
+ CIRCLE CHAISÉLONGUE



196
REVERS / H
+ DORMOUSE /

Personalità
per spazi
confortevoli.

Exceptional character,
exceptional comfort.



197
REVERS / G
+ CHAISÉLONGUE /

Linea pulita per
un divano efficiente
e funzionale.

Clean line for an efficient
and functional sofa.



198
REVERS /
G + CHAISÉLONGUE /



BRACCIOLO TIPO "A" 21 CM
ARMREST TYPE "A" 21 CM



BRACCIOLO TIPO "D" 7 CM
ARMREST TYPE "D" 7 CM



BRACCIOLO TIPO "B" 17 CM
ARMREST TYPE "B" 17 CM



BRACCIOLO TIPO "E" 3,5 CM
ARMREST TYPE "E" 3,5 CM



BRACCIOLO TIPO "C" 12 CM
ARMREST TYPE "C" 12 CM



BRACCIOLO TIPO "F" 3,5 CM
ARMREST TYPE "F" 3,5 CM





BRACCIOLO TIPO "G" 21 CM
ARMREST TYPE "G" 21 CM



BRACCIOLO TIPO "I" 21 CM
ARMREST TYPE "I" 21 CM



BRACCIOLO TIPO "H" 30 CM
ARMREST TYPE "H" 30 CM



BRACCIOLO TIPO "L" 22 CM
ARMREST TYPE "L" 22 CM

Divano letto con rete elettrosaldata e cinghie elastiche, materasso H 13 cm (materasso H 18 cm con opzione). Completamente sfoderabile con rivestimento in tessuto. Composto da elementi smontabili per facilitare il trasporto e la sfoderabilità. Montaggio degli elementi con sistema a baionetta. Struttura: agglomerato di legno foderato con tessuto vellutino termoaccoppiato ad un sottile strato di poliuretano espanso. Imbottitura: schienali e sedute in poliuretano espanso indeformabile avvolte con falda siliconata. Vano porta guanciali su retro schienale.

Sofa bed with electrowelded bed case, elastic belts and mattress H 13 cm (mattress H 18 cm with option). Fully removable covers for fabric upholstery. Composed by disassembled pieces for an easy transportation or cover removal. Assembly of pieces by metal sliding-rail brackets. Structure: wooden agglomerate lined with fine velvet fabric thermocoupled to a thin layer of polyurethane foam. Filling: back and seat cushions in indeformable polyurethane foam, silicone coated. Pillow compartment on sofa back.

**MATERASSO H 18 CM CON OPZIONE
MATTRESS H 18 CM WITH OPTION**

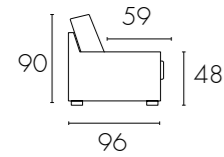

Dimensione con braccioli tipo / Size with armrests type

		A	B	C	D	E	F	G	H	I	L
	3 posti max fisso 3,5 places fix										
	3 posti max letto 3,5 places bed Materasso cm 160 x 197 Mattress cm 160 x 197	224	216	206	196	189	189	224	242	224	226
	3 posti fisso 3 places fix										
	3 posti letto 3 places bed Materasso cm 140 x 197 Mattress cm 140 x 197	204	196	186	176	169	169	204	222	204	206
	Intermedio fisso 2,5 places fix										
	Intermedio letto 2,5 places bed Materasso cm 120 x 197 Mattress cm 120 x 197	184	176	166	156	149	149	184	202	184	186
	2 posti fisso 2 places fix										
	2 posti letto 2 places bed Materasso cm 100 x 197 Mattress cm 100 x 197	164	156	146	136	129	129	164	182	164	166
	Poltrona letto Armchair bed Materasso cm 70 x 197 Mattress cm 70 x 197	134	126	116	106	99	99	134	152	134	136
	Poltrona fissa Armchair fix										
		104	96	86	76	69	69	104	122	104	106
	3 posti max laterale fisso - bracciolo DX o SX 3,5 lateral places - armrest DX o SX										
	3 posti max laterale letto - bracciolo DX o SX 3,5 lateral places bed - armrest DX o SX	203	199	194	189	186	186	203	213	203	204
	3 posti laterale fisso - bracciolo DX o SX 3 lateral places fix - armrest DX o SX										
	3 posti laterale letto - bracciolo DX o SX 3 lateral places bed - armrest DX o SX	183	179	174	169	166	166	183	193	183	184
	Intermedio laterale fisso - bracciolo DX o SX 2,5 lateral places fix - armrest right or left										
	Intermedio letto - bracciolo DX o SX 2,5 lateral places bed - armrest DX o SX	163	159	154	149	146	146	163	173	163	164

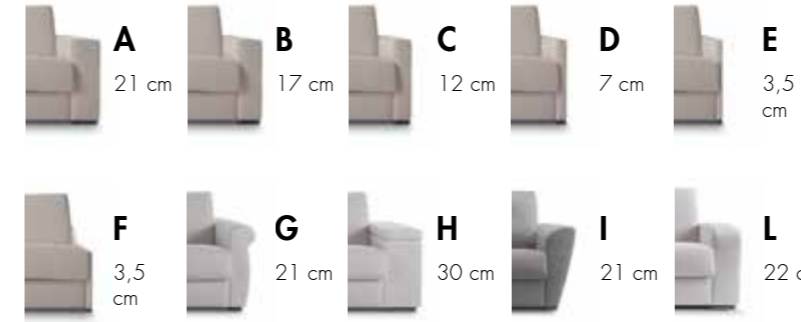

Dimensione con braccioli tipo / Size with armrests type

		A	B	C	D	E	F	G	H	I	L
	2 posti laterale fisso - bracciolo DX o SX 2 lateral places fix - armrest DX o SX										
	2 posti laterale letto - bracciolo DX o SX 2 lateral places bed - armrest DX o SX	143	139	134	129	126	126	143	153	143	144
	Poltrona laterale letto - bracciolo DX o SX Armchair lateral bed - armrest DX o SX	113	109	104	99	96	96	113	123	113	114
	Poltrona laterale fisso - bracciolo DX o SX Armchair lateral fix - armrest DX o SX	83	79	74	69	66	66	83	93	83	84
	Chaiselongue laterale tonda fissa/apribile bracciolo DX o SX lateral Circle Chaiselongue fixed/openable armrest dx o sx	103	99	94	89	86	86	103	112	103	104
	Chaiselongue laterale fissa/apribile bracciolo DX o SX Lateral fixed/stored chaiselongue armrest DX o SX	103	99	94	89	86	86	103	112	103	104
	Dormeuse laterale fissa bracciolo DX o SX Lateral fixed dormeuse armrest DX o SX	103									
	Pouff fisso/contenitore Fixed/stored pouf										



Disponibile con piedini /
available with feet /

ROCKY

206
ROCKY /
SOFA BED





Viene esaltata la pregiata
manifattura italiana.

It is exalted by the
fine Italian manufacture.



209
ROCKY /
SOFA BED

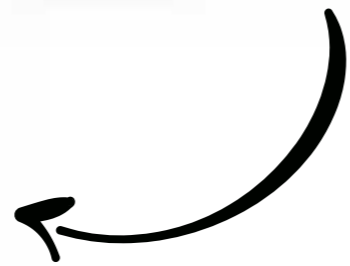
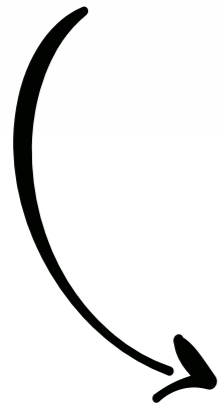

211
ROCKY /
SOFA BED





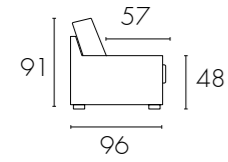

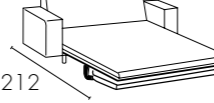

Divano letto con rete elettrosaldata e cinghie elastiche, materasso H 13 cm.
 Completamente sfoderabile (ad eccezione dei cuscini schienali) con rivestimento in tessuto. Composto da elementi smontabili per facilitare il trasporto e la sfoderabilità. Montaggio degli elementi con sistema a baionetta. Struttura: agglomerato di legno foderato con tessuto vellutino termoaccoppiato ad un sottile strato di poliuretano espanso. Imbottitura: cuscini schienali in fiocco di fibra di poliestere 200g/m³ e sedute in poliuretano espanso indeformabile avvolte con falda siliconata.

Sofa bed with electrowelded bed case, elastic belts and mattress H 13 cm.
 Fully removable covers (with the exception of the backrest cushions) for fabric upholstery. Composed by disassembled pieces for an easy transportation or cover removal. Assembly of pieces by metal sliding-rail brackets. Structure: wooden agglomerate lined with fine velvet fabric thermocoupled to a thin layer of polyurethane foam. Filling: backrest cushions made of polyester fiber flakes 200 g/m³ and seat cushions in indeformable polyurethane foam, silicone coated.

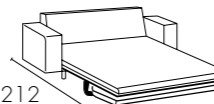

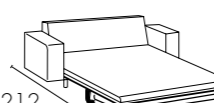
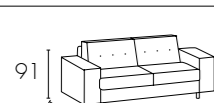
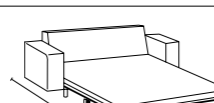
Dimensione con braccioli tipo / Size with armrests type

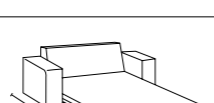
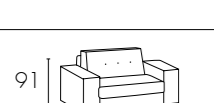
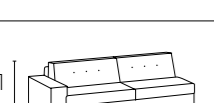
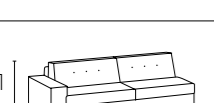
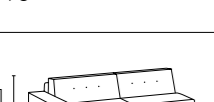
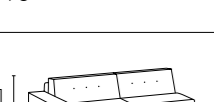
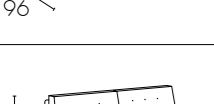
A

	3 posti max fisso 3,5 places fix		3 posti max letto 3,5 places bed Materasso cm 160 x 197 Mattress cm 160 x 197	214
	3 posti fisso 3 places fix		3 posti letto 3 places bed Materasso cm 140 x 197 Mattress cm 140 x 197	194
	Intermedio fisso 2,5 places fix		Intermedio letto 2,5 places bed Materasso cm 120 x 197 Mattress cm 120 x 197	174
	2 posti fisso 2 places fix		2 posti letto 2 places bed Materasso cm 100 x 197 Mattress cm 100 x 197	154
	Poltrona fisso Armchair fix		Poltrona letto Armchair bed Materasso cm 70 x 197 Mattress cm 70 x 197	124
	Poltrona fisso Armchair fix			94
	3 posti max laterale fisso - bracciolo DX o SX 3,5 lateral places - armrest DX o SX		3 posti max laterale letto - bracciolo DX o SX 3,5 lateral places bed - armrest DX o SX	199
	3 posti laterale fisso - bracciolo DX o SX 3 lateral places fix - armrest DX o SX		3 posti laterale letto - bracciolo DX o SX 3 lateral places bed - armrest DX o SX	179
	Intermedio laterale fisso - bracciolo DX o SX 2,5 lateral places fix - armrest right or left		Intermedio letto - bracciolo DX o SX 2,5 lateral places bed - armrest DX o SX	159





A
15 cm

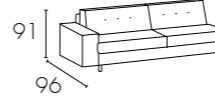
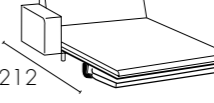
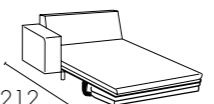

Dimensione con braccioli tipo / Size with armrests type

A

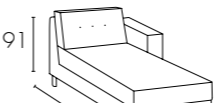
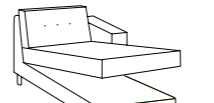
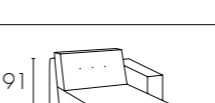
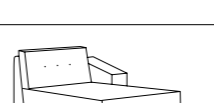
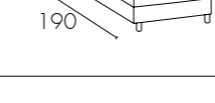
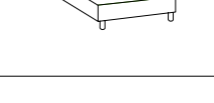
	2 posti laterale fisso - bracciolo DX o SX 2 lateral places fix - armrest DX o SX		2 posti laterale letto - bracciolo DX o SX 2 lateral places bed - armrest DX o SX	139
	Poltrona laterale letto - bracciolo DX o SX Armchair lateral bed - armrest DX o SX			109
	Poltrona laterale fisso - bracciolo DX o SX Armchair lateral fix - armrest DX o SX			79
	Chaiselongue laterale fissa/apribile bracciolo DX o SX Lateral fixed/storaged chaiselongue armrest DX o SX			97
	Chaiselongue laterale fissa/apribile bracciolo DX o SX Lateral fixed/storaged chaiselongue armrest DX o SX			97
	Pouff fisso/contenitore Fixed/storaged pouf			



Disponibile con piedini /
available with feet /

SHINE



215
SHINE /
SOFA BED

Dal design moderno ed essenziale,
coniuga bellezza e funzionalità.

Essential and modern design, it
combines beauty and functionality.



216
SHINE /
SOFA BED





218
SHINE /
SOFA BED



Divano letto con rete elettrosaldata e cinghie elastiche, materasso H 13 cm (materasso H 18 cm con opzione). Completamente sfoderabile con rivestimento in tessuto. Composto da elementi smontabili per facilitare il trasporto e la sfoderabilità. Montaggio degli elementi con sistema a baionetta. Struttura: agglomerato di legno foderato con tessuto vellutino termocoppiato ad un sottile strato di poliuretano espanso. Imbottitura: schienali e sedute in poliuretano espanso indeformabile avvolte con falda siliconata.

Sofa bed with electrowelded bed case, elastic belts and mattress H 13 cm (mattress H 18 cm with option). Fully removable covers for fabric upholstery. Composed by disassembled pieces for an easy transportation or cover removal. Assembly of pieces by metal sliding-rail brackets. Structure: wooden agglomerate lined with fine velvet fabric thermocoupled to a thin layer of polyurethane foam. Filling: back and seat cushions in indeformable polyurethane foam, silicone coated.

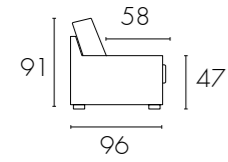
**MATERASSO H 18 CM CON OPZIONE
MATTRESS H 18 CM WITH OPTION**



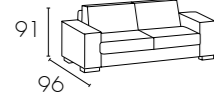
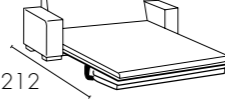
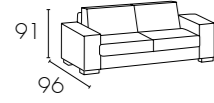
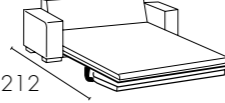
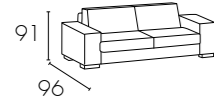
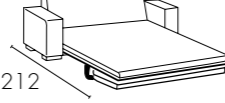
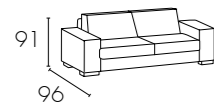
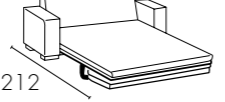
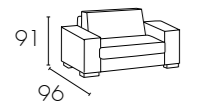

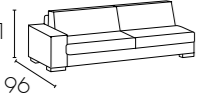
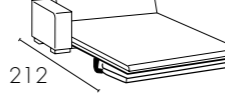
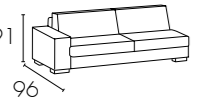
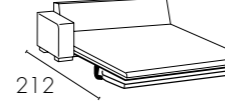
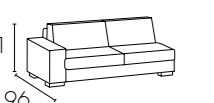
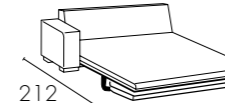
Dimensione con braccioli tipo / Size with armrests type

		A
	3 posti max fisso 3,5 places fix	212
	3 posti max letto 3,5 places bed Materasso cm 160 x 197 Mattress cm 160 x 197	
	3 posti fisso 3 places fix	212
	3 posti letto 3 places bed Materasso cm 140 x 197 Mattress cm 140 x 197	
	Intermedio fisso 2,5 places fix	212
	Intermedio letto 2,5 places bed Materasso cm 120 x 197 Mattress cm 120 x 197	
	2 posti fisso 2 places fix	212
	2 posti letto 2 places bed Materasso cm 100 x 197 Mattress cm 100 x 197	
	Poltrona fissa Armchair fix	212
	Poltrona letto Armchair bed Materasso cm 70 x 197 Mattress cm 70 x 197	
	3 posti max laterale fisso - bracciolo DX o SX 3,5 lateral places - armrest DX o SX	212
	3 posti max laterale letto - bracciolo DX o SX 3,5 lateral places bed - armrest DX o SX	
	3 posti laterale fisso - bracciolo DX o SX 3 lateral places fix - armrest DX o SX	212
	3 posti laterale letto - bracciolo DX o SX 3 lateral places bed - armrest DX o SX	
	Intermedio laterale fisso - bracciolo DX o SX 2,5 lateral places fix - armrest right or left	212
	Intermedio letto - bracciolo DX o SX 2,5 lateral places bed - armrest DX o SX	

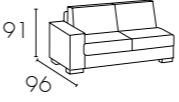
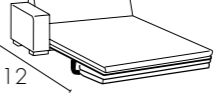
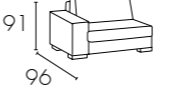

Dimensione con braccioli tipo / Size with armrests type

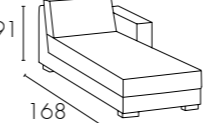
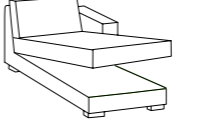
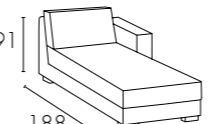
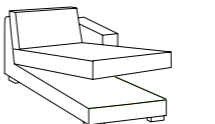
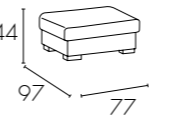
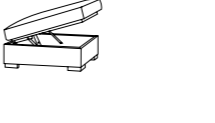
		A
	2 posti laterale fisso - bracciolo DX o SX 2 lateral places fix - armrest DX o SX	212
	2 posti laterale letto - bracciolo DX o SX 2 lateral places bed - armrest DX o SX	
	Poltrona laterale fisso - bracciolo DX o SX Armchair lateral fix - armrest DX o SX	212
	Poltrona laterale letto - bracciolo DX o SX Armchair lateral bed - armrest DX o SX	
	Chaiselongue laterale fissa/apribile bracciolo DX o SX Lateral fixed/storaged chaiselongue armrest DX o SX	168
		
	Chaiselongue laterale fissa/apribile bracciolo DX o SX Lateral fixed/storaged chaiselongue armrest DX o SX	188
		
	Pouff fisso/contenitore Fixed/storaged pouff	44
		
		97
		77



Disponibile con piedini /
available with feet /

MIRA



223
MIRA /
SOFA BED



Linea pulita per
un divano efficiente
e funzionale.

Clean line for an efficient
and functional sofa.



224
MIRA /
SOFA BED



DIVANO CON DOPIO LETTO con rete elettrosaldata e cinghie elastiche, materasso H 13 cm.
 Completamente sfoderabile con rivestimento in tessuto. Composto da elementi smontabili per facilitare il trasporto e la sfoderabilità.
 Struttura: agglomerato di legno foderato con tessuto vellutino termocoppiato ad un sottile strato di poliuretano espanso. Imbottitura: schienali e sedute in poliuretano espanso indeformabile avvolte con falda siliconata.

SOFA WITH DOUBLE BED with electrowelded bed case, elastic belts and mattress H 13 cm.
 Fully removable covers for fabric upholstery.
 Composed by disassembled pieces for an easy transportation or cover removal.
 Structure: wooden agglomerate lined with fine velvet fabric thermocoupled to a thin layer of polyurethane foam.
 Filling: back and seat cushions in indeformable polyurethane foam, silicone coated.

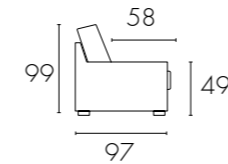

Dimensione con braccioli tipo / Size with armrests type

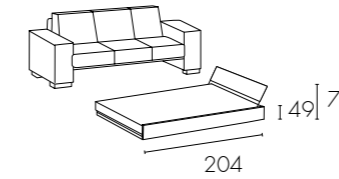
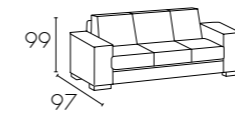

3 posti max letto
 3,5 places bed
 Materasso cm 80 x 190 x 14
 Mattress cm 80 x 190 x 14

A	B
225	204

Doppio materasso 80 x 190 h14
 Double mattress 80 x 190 h14



A
 14 cm



B
 3,5 cm



LWE



LCI



LBI



LAL

Disponibile con piedini solo per bracciolo tipo A / Available with feet only for type A armrest /

MARLEN



229
MARLEN /
SOFA BED



La perfetta sinergia tra lo stile classico e le linee moderne.

The perfect synergy between classical and modern lines.



231
MARLEN /
SOFA BED



232
MARLEN /
SOFA BED

Divano letto con rete elettrosaldata e cinghie elastiche, materasso H 13 cm (materasso H 18 cm con opzione). Completamente sfoderabile con rivestimento in tessuto. Composto da elementi smontabili per facilitare il trasporto e la sfoderabilità. Montaggio degli elementi con sistema a baionetta. Struttura: agglomerato di legno foderato con tessuto vellutino termocoppato ad un sottile strato di poliuretano espanso. Imbottitura: cuscini schienali in fiocco di fibra di poliestere 200g/m3 e sedute in poliuretano espanso indeformabile avvolte con falda siliconata.

Sofa bed with electrowelded bed case, elastic belts and mattress H 13 cm (mattress H 18 cm with option). Fully removable covers for fabric upholstery. Composed by disassembled pieces for an easy transportation or cover removal. Assembly of pieces by metal sliding-rail brackets. Structure: wooden agglomerate lined with fine velvet fabric thermocoupled to a thin layer of polyurethane foam. Filling: backrest cushions made of polyester fiber flakes 200 g/m3 and seat cushions in indeformable polyurethane foam, silicone coated.

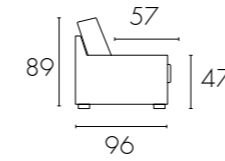

**MATERASSO H 18 CM CON OPZIONE
MATTRESS H 18 CM WITH OPTION**

Dimensione con braccioli tipo / Size with armrests type

				A
	3 posti max fisso 3,5 places fix		3 posti max letto 3,5 places bed Materasso cm 160 x 197 Mattress cm 160 x 197	244
	3 posti fisso 3 places fix		3 posti letto 3 places bed Materasso cm 140 x 197 Mattress cm 140 x 197	224
	Intermedio fisso 2,5 places fix		Intermedio letto 2,5 places bed Materasso cm 120 x 197 Mattress cm 120 x 197	204
			Pouff fisso/contenitore Fixed/storaged pouf	



Disponibile con piedini /
available with feet /

CHANTAL



235
CHANTAL /
SOFA BED

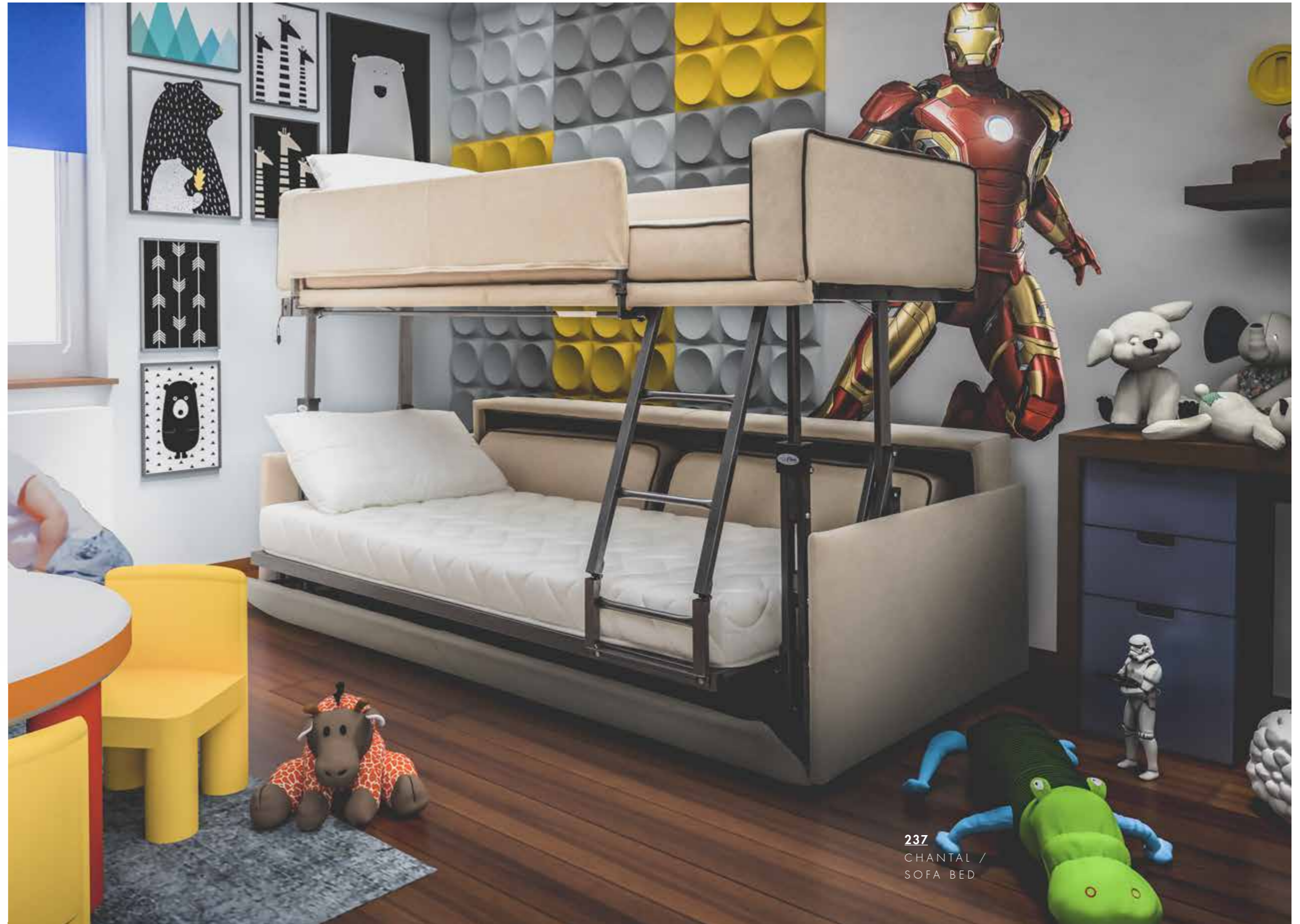

La sua linea moderna
è arricchita da una bordatura
che disegna ed esalta
i profili morbidi del divano.

Its modern style is enhanced
by a border with designs and
exalts the sofa soft profiles.



238
CHANTAL /
SOFA BED



DIVANO CON DOPPIO LETTO A CASTELLO con rete elettrosaldata e cinghie elastiche, materasso H 13 cm.
 Completamente sfoderabile con rivestimento in tessuto. Composto da elementi smontabili per facilitare il trasporto e la sfoderabilità. Montaggio degli elementi con sistema a baionetta. Struttura: agglomerato di legno foderato con tessuto vellutino termocoppiato ad un sottile strato di poliuretano espanso. Imbottitura: schienali e sedute in poliuretano espanso indeformabile avvolte con falda siliconata.

SOFA WITH DOUBLE BUNK BED with electrowelded bed case, elastic belts and mattress H 13 cm. Fully removable covers for fabric upholstery. Composed by disassembled pieces for an easy transportation or cover removal. Assembly of pieces by metal sliding-rail brackets. Structure: wooden agglomerate lined with fine velvet fabric thermocoupled to a thin layer of polyurethane foam. Filling: back and seat cushions in indeformable polyurethane foam, silicone coated.

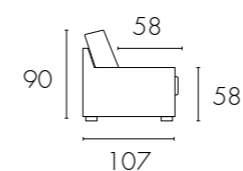

Dimensione con braccioli tipo / Size with armrests type

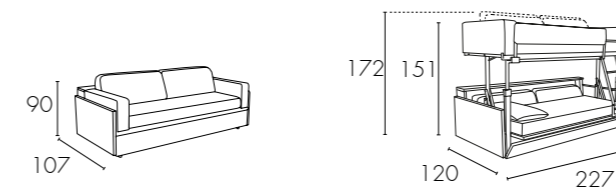

2 posti letto
 2 places bed

Materasso cm 80 x 190
 Mattress cm 80 x 190

Doppio materasso 80 x 190 h14
 Double mattress 80 x 190 h14

A

227



MOON

La poltrona MOON associa una linea classica alla massima funzionalità diventando, all'occasione, un letto confortevole.

MOON associates a classic line with maximum functionality, becoming a comfortable bed when needed.

Materasso h12 76x197 cm Densità 21
Mattress h12 76x197 cm Density 21

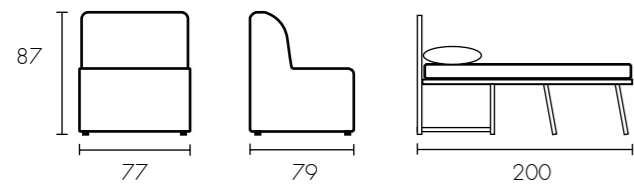

243
MOON /
ARMCHAIR BED

FUNNY

FUNNY associa una linea classica alla massima funzionalità diventando, all'occasione, un letto confortevole.

FUNNY associates a classic line with maximum functionality, becoming a comfortable bed when needed.

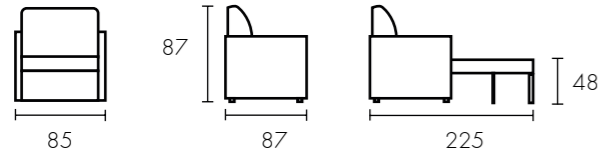

Materasso h12 70x190 cm
Mattress h12 70x190 cm



244
FUNNY /

OMAR

Un pouf funzionale che all'occorrenza può essere utilizzato come letto.

A functional pouf that can be used as a bed if needed.

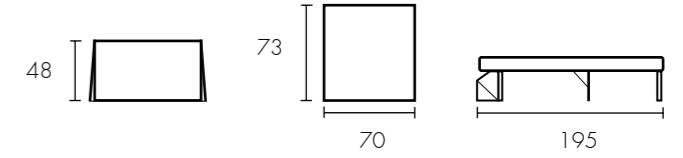

Materasso h12 70x190 cm
Mattress h12 70x190 cm



245
OMAR /

TAIPEI



246
TAIPEI /

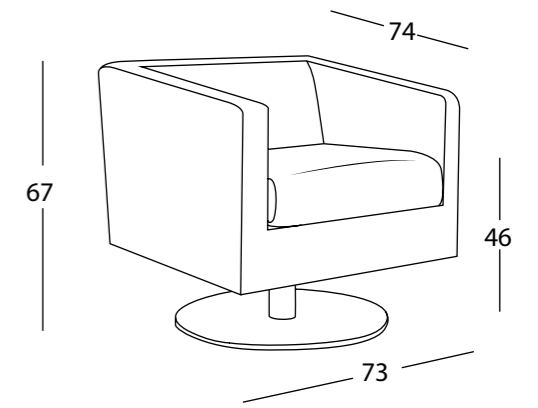

Grazie al suo design dalle linee minimali e rettangolari è adatta sia agli ambienti domestici che professionali.

Thanks to its design with minimal and rectangular lines, it is perfect both in domestic and professional environments.



LAGOS

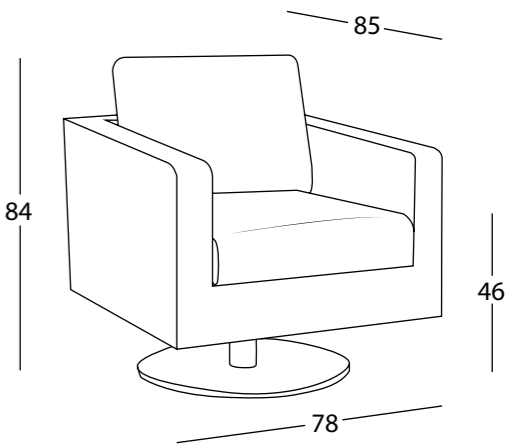

Variante della poltrona Taipei, con un morbido e più alto schienale.

Variant of Taipei armchair, with a soft and higher backrest.



ATENE



250
ATENE /

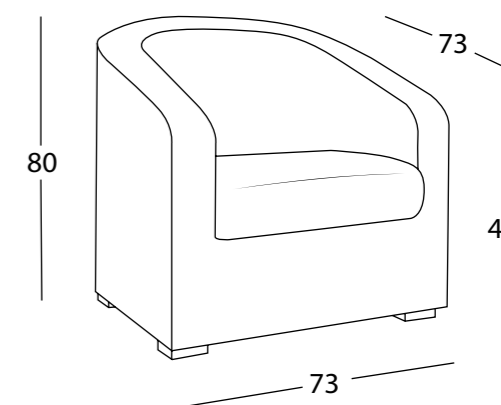

Disponibile con piedini /
available with feet /



La sua forma piacevole ed
avvolgente le dona stile e
comodità.

Its pleasant and enveloping shape gives
it style and comfort.



MUNICH



252
MUNICH /

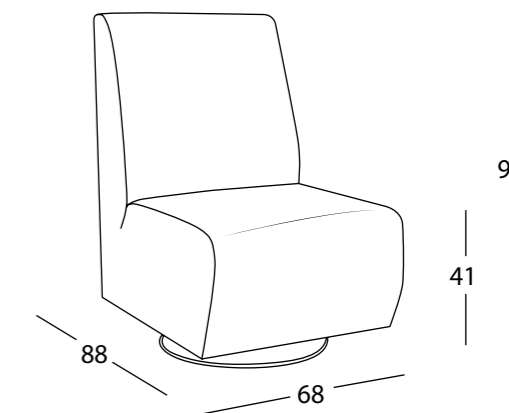

Linee morbide e soffici per la poltrona Munich, con base girevole in metallo.

Modern and soft lines for the armchair Munich, based on a swivel metal base.



PRETTY

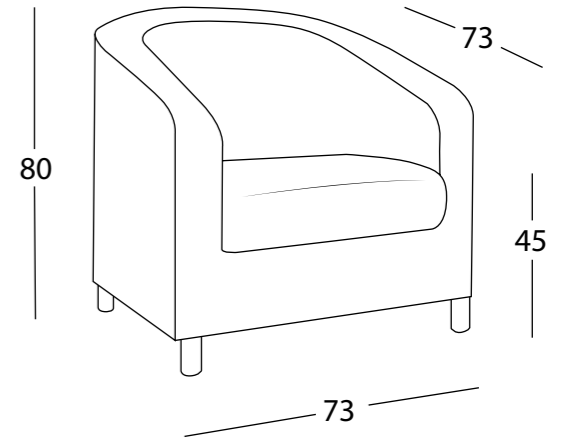

Pretty mescola classico e contemporaneo in una linea essenziale, ideale sia per il contract sia per la casa.

Pretty mixes classic and contemporary features in a basic line, perfect for contract projects and domestic solutions.



SANTIAGO



Il comfort è garantito dalla forma rassicurante e dall'estrema morbidezza dell'imbottitura.

The reassuring shape and the extreme softness of the padding guarantee the Santiago chair comfort.

Disponibile con piedini / available with feet /



LWE

LCI

LBI

LAL

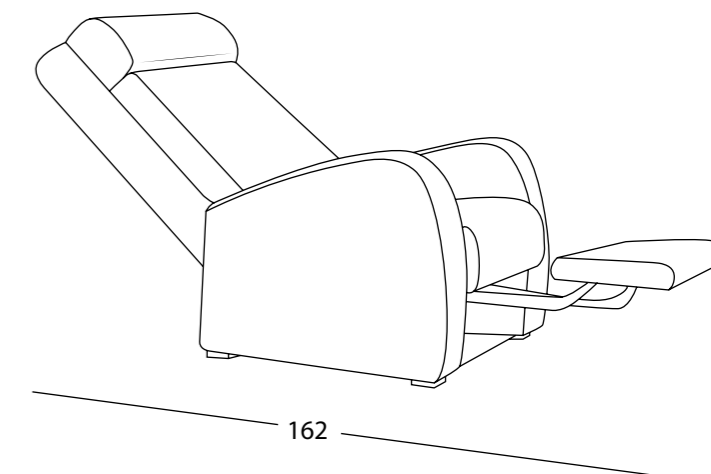
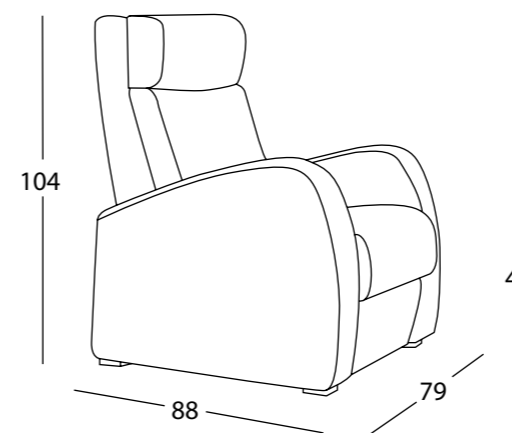

Esempi di alcuni modelli
Alterego nella versione
poltrone / poltrone-letto



Examples of some Alterego
models in the armchair /
armchair-bed version



SQUARE



POUF dal design moderno e metropolitano, un elemento d'arredo che merita di essere considerato un vero "jolly" riuscendo ad abbinarsi in modo perfetto ai più disparati contesti contemporanei.

POUF with a modern and metropolitan design, a piece of furniture that deserves to be considered a true "wild card", being able to perfectly match the most diverse contemporary contexts.

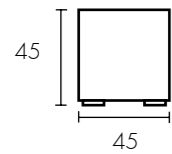

Disponibile con piedini /
available with feet /



MATERASSI
MECCANISMI
REVERSIBILITÀ
CARATTERISTICHE
TESSUTI

MATTRESS
MECHANISMS
REVERSIBLE
FEATURES
FABRICS

Comfort Bultex®

Materasso H 14 / Mattress H 14 / Matelas H 14

CLASSIQUE

Un comfort morbido e progressivo grazie alla tecnica comfort BULTEX della schiuma di lattice microcellulare. Questa tecnica garantisce un supporto del corpo perfettamente bilanciato e un'eccellente ventilazione del materasso.

CLASSIQUE

Soft and progressive comfort thanks to the BULTEX comfort technique of the microcellular latex foam. This technique guarantees a perfectly balanced body support and excellent ventilation of the mattress.

CLASSIQUE

Un confort souple et progressif grâce à la technique du confort BULTEX de mousse latex micro alvéolé. Cette technique vous garantit un maintien parfaitement équilibré du corps ainsi qu'une excellente ventilation du matelas.



MATERASSO CON OPZIONE
MATTRESS OPTION
MATELAS AVEC OPTION

DENSITÀ 38 KG / M3
DENSITY 38 KG / M3

IPOALLERGENICO
HYPOALLERGENIC

TRATTAMENTI ANTI-ACARO
E ANTIBATTERICO
ANTI-MITE TREATMENTS
AND ANTIBACTERIAL

STRETCH 100% POLIESTERE
100% POLYESTER STRETCH

SPESSORE 14 CM
THICKNESS 14 CM

LUNGHEZZA 195 CM
LENGTH 195 CM

MORBIDO COMFORT
SOFT COMFORT

feel the
Sensation.

Materasso H 16 / Mattress H 16 / Matelas H 16

OPTIMUM

Un comfort morbido e progressivo grazie alla tecnica comfort BULTEX della schiuma di lattice microcellulare. Questa tecnica garantisce un supporto del corpo perfettamente bilanciato e un'eccellente ventilazione del materasso.

OPTIMUM

Soft and progressive comfort thanks to the BULTEX comfort technique of the microcellular latex foam. This technique guarantees a perfectly balanced body support and excellent ventilation of the mattress.

OPTIMUM

Un confort souple et progressif grâce à la technique du confort BULTEX de mousse latex micro alvéolé. Cette technique vous garantit un maintien parfaitement équilibré du corps ainsi qu'une excellente ventilation du matelas.



MATERASSO CON OPZIONE
MATTRESS OPTION
MATELAS AVEC OPTION

DENSITÀ 45 KG / M3
DENSITY 45 KG / M3

IPOALLERGENICO
HYPOALLERGENIC

TRATTAMENTI ANTI-ACARO
E ANTIBATTERICO
ANTI-MITE TREATMENTS
AND ANTIBACTERIAL

STRETCH 100% POLIESTERE
100% POLYESTER STRETCH

SPESSORE 16 CM
THICKNESS 16 CM

LUNGHEZZA 195 CM
LENGTH 195 CM

MORBIDO COMFORT
SOFT COMFORT

Comfort Bultex® est une marque déposée par Recticel

comfort
BULTEX®
supports life

Materassi H 13 / Mattress H 13 / Matelas H 13

STANDARD D25

Materasso in poliuretano di media densità rivestito in tessuto di poly-cotone losangato solo da un lato.



STANDARD D25

Mattress in polyurethane with medium density, covered with Quilted poly-cotton fabric and with anti-dust mite treatment.

STANDARD D25

Matelas en polyuréthane à densité moyenne. Recouvert de tissu en poly-coton losangé d'un seul côté.

MATERASSO DI SERIE
STANDARD MATTRESS
MATELAS DE SÉRIE

ANALLERGICO E ANTIBATTERICO
ANTIBACTERIAL- ANTI MITE
ANALLERGIQUE

POLTEX D35

Con i suoi 13 cm H il materasso poltex ad alta densità si colloca nella fascia dei materassi da letto assicurandone massimo comfort. È consigliato per un uso quotidiano del divano trasformabile. Rivestito con tessuto stretch anti acaro e anallergico.



POLTEX D35

Our mattress model Poltex H 13 cm has a high density. It is a real bed mattress recommended for those who use the sofa bed daily. Covered with hypoallergenic and anti-dust mite stretch fabric.

POLTEX D35

Matelas Poltex 13 cm H à haute densité. Il est placé dans le bande de matelas de lit en assurant confort extreme. Il est recommandé pour une utilisation quotidienne du canapé-lit. Recouvert de tissu extensible anti-acarien et anallergique.

ANALLERGICO E ANTIBATTERICO
ANTIBACTERIAL- ANTI MITE
ANALLERGIQUE

ALTA DENSITÀ
HIGH DENSITY
HAUTE DENSITÉ

TESSUTO STRETCH
STRETCH FABRIC
EXTENSIBLE TISSU

MATERASSO CON OPZIONE
MATTRESS OPTION
MATELAS AVEC OPTION

Materassi H 13 / Mattress H 13 / Matelas H 13

TOPPER SFODERABILE D35

Materasso con supporto in poliuretano ad altissima resilienza e con **TOPPER TRAPUNTA-TO CON MEMORY FOAM**.

Questo sistema rende il materasso comodo e di alta qualità. Rivestito con tessuto stretch antiacaro e anallergico.



MATERASSO CON OPZIONE
MATTRESS OPTION
MATELAS AVEC OPTION

TOPPER REMOVABLE D35

Mattress with high resilience and polyurethane **CORE WITH MEMORY FOAM QUILTED TOPPER**. This system makes very

high the quality of this mattress. Mattress covered with hypoallergenic and dust mite stretch fabric.

TOPPER DÉHOUSSABLE D35

Matelas avec support en polyuréthane à haute résilience et avec **TOPPER MATELAS-SÉ EN MEMORY FOAM**. Ce système rend

le matelas confortable et de haute qualité. Recouvert de tissu extensible anti-acarien et anallergique.

ANALLERGICO E ANTIBATTERICO
ANTIBACTERIAL- ANTI MITE
ANALLERGIQUE

MEMORY FOAM
CONFORT MEMORY
MOUSSE À MÉMOIRE DE FORME

ALTA DENSITÀ
HIGH DENSITY
HAUTE DENSITÉ

TESSUTO STRETCH
STRETCH FABRIC
EXTENSIBLE TISSU

LAVAGGIO A SECCO
DRY CLEANING
NOTTOYAGE À SEC



Materassi H 18 / Mattress H 18 / Matelas H 18

MEDICAL D28

Materasso in poliuretano di media densità rivestito in tessuto di poly-cotone losangato solo da un lato.



MEDICAL D28

Mattress in polyurethane with medium density, covered with quilted poly-cotton fabric and with anti-dust mite treatment.

MEDICAL D28

Matelas en polyuréthane à densité moyenne. Recouvert de tissu en poly-coton losangé d'un seul côté.

MATERASSO CON OPZIONE
MATTRESS OPTION
MATELAS AVEC OPTION

ANALLERGICO E ANTIBATTERICO
ANTIBACTERIAL- ANTI MITE
ANALLERGIQUE

COMFORT D30 STRETCH

Con i suoi 18 cm H il materasso poltex ad alta densità si colloca nella fascia dei materassi da letto assicurandone massimo comfort. È consigliato per un uso quotidiano del divano trasformabile. Rivestito con tessuto stretch anti acaro e anallergico.



COMFORT D30 STRETCH

Our mattress model Poltex H 18 cm has a high density. It is a real bed mattress recommended for those who use the sofa bed daily. Covered with hypoallergenic and anti-dust mite stretch fabric.

COMFORT D30 STRETCH

Matelas Poltex 18 cm H à haute densité. Il est placé dans le bande de matelas de lit en assurant confort extreme. Il est recommandé pour une utilisation quotidienne du canapé-lit. Recouvert de tissu extensible anti-acarien et anallergique.

ANALLERGICO E ANTIBATTERICO
ANTIBACTERIAL- ANTI MITE
ANALLERGIQUE

ALTA DENSITÀ
HIGH DENSITY
HAUTE DENSITÉ

MATERASSO CON OPZIONE
MATTRESS OPTION
MATELAS AVEC OPTION

TESSUTO STRETCH
STRETCH FABRIC
EXTENSIBLE TISSU

Materassi H 18 / Mattress H 18 / Matelas H 18

DREAM D40 STRETCH

Materasso in poliuretano ad altissima resilienza e con bassa percentuale di deformazione. Questo è garanzia di un ottimo comfort nel momento del riposo. Rivestito con tessuto stretch anti acaro e anallergico.



DREAM D40 STRETCH

Polyuretane foam mattress with a high resiliency, and a low percentage of deformation, this a guarantee for a very high comfort for your rest. Covered with hypoallergenic and dust mite.

DREAM D40 STRETCH

Matelas en polyuréthane à haute résilience et faible pourcentage de déformation. Cela garantit un confort optimal pendant le repos. Recouvert de tissu extensible anti-acarien et anallergique.

ANALLERGICO E ANTIBATTERICO
ANTIBACTERIAL- ANTI MITE
ANALLERGIQUE

ALTA DENSITÀ
HIGH DENSITY
HAUTE DENSITÉ

TESSUTO STRETCH
STRETCH FABRIC
EXTENSIBLE TISSU

MATERASSO CON OPZIONE
MATTRESS OPTION
MATELAS AVEC OPTION

Attenzione / Attention / Attention

Differenza di altezza dei divani letto con materasso H 13 a H 18

The height difference between the sofa-bed with a 18 cm mattress and sofa-bed with a 13 cm mattress

Différence de hauteur des canapés-lits à partir de matelas H cm 13 à matelas H cm 18

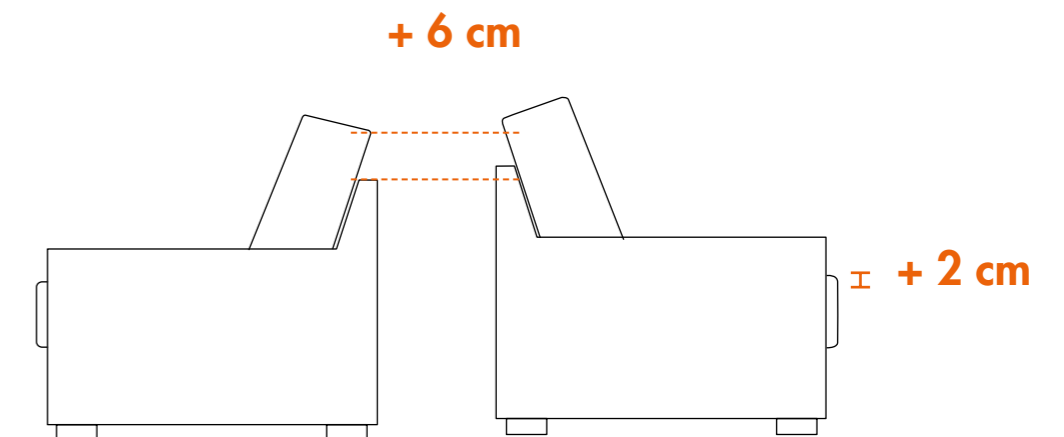

Meccanismi a ribalta / Mechanisms / Mécanismmes rabattables

FAST H13

Meccanismo a ribalta con sistema di apertura semplice. Telaio ad alta resistenza con verniciatura epossidica. Piano dormita con rete in acciaio elettrosaldato e cinghie elastiche.

MECCANICA DI SERIE
STANDART MECHANISM
MÉCANIQUE DE SÉRIE



FAST H13

Revolving mechanisms with easy opening system. High resistance frame with epoxy painting. Sleeping surface with base in fuse-bonded steel and elastic straps.

FAST H13

Mécanisme rabattable avec système d'ouverture simple. Cadre à haute résistance avec de la peinture époxy. Surface de couchage avec réseau en acier soudé et sangles élastiques.



HEIGHT COMFORT PRIVILEGE H18

Meccanismo a ribalta con sistema di apertura semplice. Telaio ad alta resistenza con verniciatura epossidica. Piano dormita con rete in acciaio elettrosaldato plastificata e cinghie elastiche.

MECCANICA CON OPZIONE
MECHANISM OPTION
MÉCANIQUE AVEC OPTION



HEIGHT COMFORT PRIVILEGE H18

Revolving mechanisms with easy opening system. High resistance frame with epoxy painting. Sleeping surface with base in fuse-bonded steel, plastified and elastic straps.

HEIGHT COMFORT PRIVILEGE H18

Mécanisme rabattable avec système d'ouverture simple. Cadre à haute résistance avec de la peinture époxy. Surface de couchage avec réseau en acier plastique soudé et sangles élastiques.



Meccanismi a ribalta / Mechanisms / Mécanismmes rabattables

FAST DOGHE H13

Il meccanismo è fornito con innesti a baionetta che facilita il montaggio e smontaggio (braccioli, schienale, fascia) del divano, risolvendo il problema della movimentazione durante il trasporto.

MECCANICA CON OPZIONE PER MATERASSI H13 E H14
MECHANISM OPTION FOR MATTRESS H13 AND H14
MÉCANIQUE AVEC OPTION POUR MATELAS H13 ET H14



FAST DOGHE H13

The mechanic is supplied with bayonet fittings that makes easier the sofa's assembly (arms, back, sash), resolving the movement problem during the transport.

FAST DOGHE H13

Le mécanisme est fourni avec des greffes à baïonnette qui facilitent le montage et démontage (accoudoirs, dossier, bandeau) du canapé, en résolvant ainsi le problème de manipulation durant le transport.



Meccanismo da inserimento con sistema di apertura semplice ed unico, che consente di non rimuovere i cuscini della seduta e dello schienale del divano.

Insertion mechanism with unique and easy opening system, which consents to do not remove the sitting cushions and the back of the sofa.

Il meccanismo è fornito con doghe curve in faggio, che rendono il piano dormita ortopedico.

The mechanism is supplied with beech curved slats, which make the sleep surface orthopaedic.



Telaio in tubo da mobilio ad alta resistenza con verniciatura epossidica.

Tubular frame for furniture with high resistance with epoxy painting.



Meccanismi a ribalta / Mechanisms / Mécanismes rabattables

HEIGHT COMFORT PRIVILEGE DOGHE H16

Il meccanismo è fornito con innesti a baionetta che facilita il montaggio e smontaggio (braccioli, schienale, fascia) del divano, risolvendo il problema della movimentazione durante il trasporto.

MECCANICA CON OPZIONE PER MATERASSI H16
MECHANISM OPTION FOR MATTRESS H16
MÉCANIQUE AVEC OPTION POUR MATELAS H16

HEIGHT COMFORT PRIVILEGE DOGHE H16

The mechanic is supplied with bayonet fittings that makes easier the sofa's assembly (arms, back, sash), resolving the movement problem during the transport.

HEIGHT COMFORT PRIVILEGE DOGHE H16

Le mécanisme est fourni avec des greffes à baïonnette qui facilitent le montage et démontage (accoudoirs, dossier, bandeau) du canapé, en résolvant ainsi le problème de manipulation durant le transport.



Meccanismi a ribalta / Mechanisms / Mécanismes rabattables

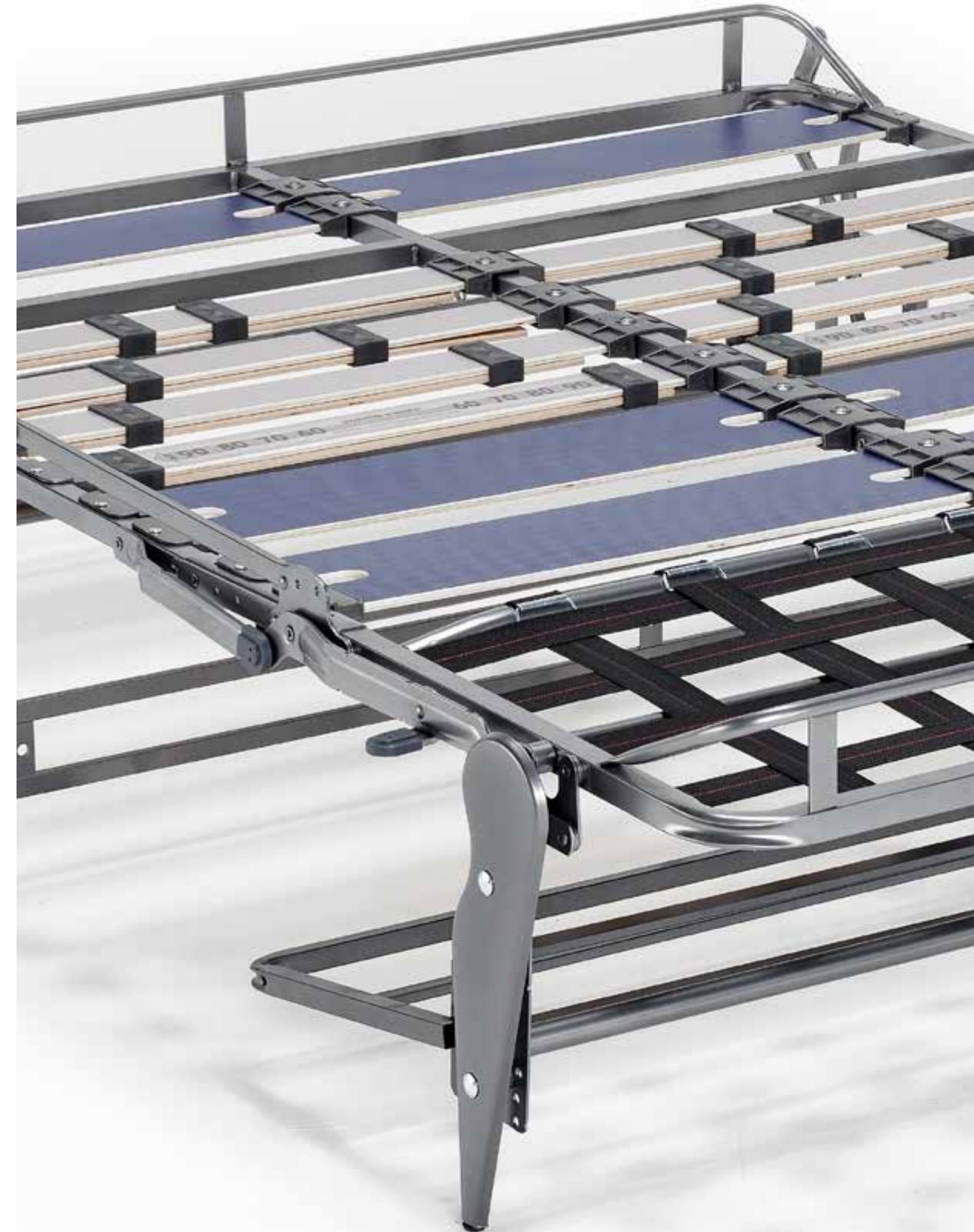

Meccanismo da inserimento con sistema di apertura semplice ed unico, che consente di non rimuovere i cuscini della seduta e dello schienale del divano.

Insertion mechanism with unique and easy opening system, which consents to do not remove the sitting cushions and the back of the sofa.

Il piano dormita utilizza **doghe in legno** (materiale green – ecocompatibile) di varie rigidità che determinano un **piano dormita differenziato a zone** e regolabile in modo semplice.

The sleeping surface is made of **wooden slats** (green – eco friendly) that have **various tension levels** for a differentiated and adjustable sleeping surface.

Telaio in tubo da mobilio ad alta resistenza con verniciatura epossidica.

Tubular frame for furniture with high resistance with epoxy painting.

Optional per meccanismi a ribalta

Mechanisms' optional / En option sur les mécanismes rabattables



LIFT UP

Innovativo sistema per tutti i meccanismi a ribalta, utile per il sollevamento del divano e per un facile spostamento.

LIFT UP

Innovative system for all evolving mechanisms, useful for the lifting of the sofa and easy movement.



LIFT UP

Système innovant pour tous les mécanismes rabattables, utile pour le soulèvement du canapé et pour faciliter le mouvement/déplacement.

Completamente smontabile

Completely dismantled / Complètement démontable

Completamente smontabile per facilitare il trasporto e la sfoderabilità. Montaggio degli elementi con sistema a baionetta.

The sofa can be easily dismantled for transportation or for cover removal. Assembling of the pieces by metal sliding-rail brackets.

Complètement démontable - Éléments séparables pour faciliter le transport ou pour dehousser complèment le canapé. Système à glissières pour le montage des accoudoirs et du dossier.



Reversibilità

/ Reversible / Réversibilité

Tutti i nostri divani letto sono reversibili / All of our sofa beds are reversible / Tous nos canapés convertibles sont réversibles

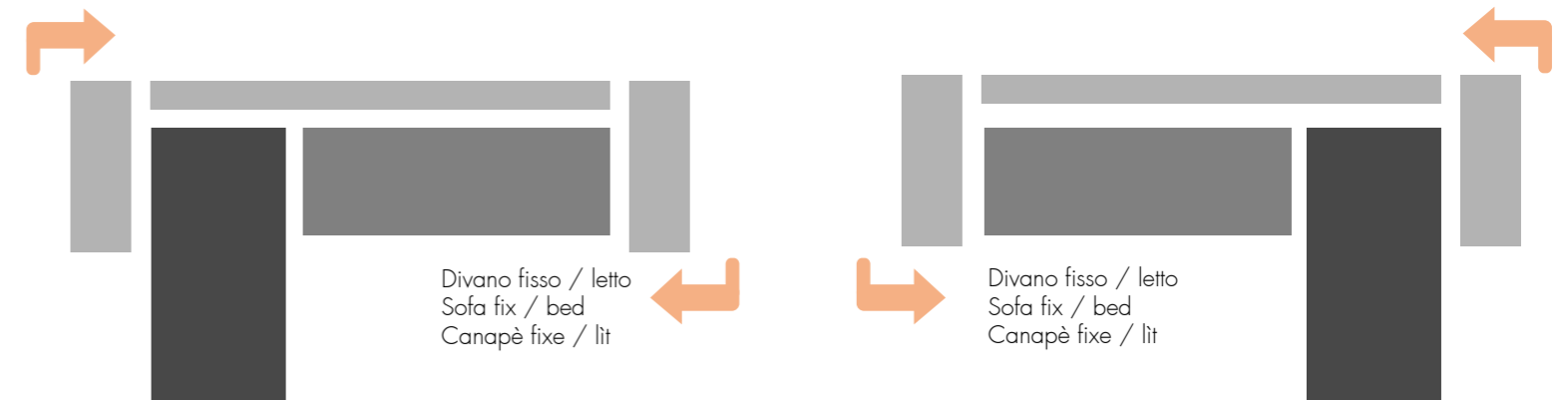

Chaiselongue fissa / apribile
Fixed / storage chaiselongue
Chaiselongue fixe / ouvrant

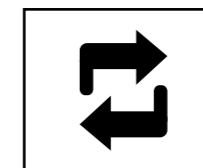

Chaiselongue fissa / apribile
Fixed / storage chaiselongue
Chaiselongue fixe / ouvrant

CUSCINETTI DECORO / PILLOWS

Notes



CUSCINETTO DECORO STANDARD

standard pillow

45 x 45 cm



CUSCINETTO DECORO CON BORDINO

pillow with edge

45 x 45 cm



CUSCINETTO DECORO QUADRATO CON FASCIA

square pillow with band

47 x 47 x 7 cm



CUSCINETTO DECORO RETTANGOLARE CON FASCIA

rectangular pillow with band

47 x 32 x 5 cm

Graphic design
Photography and 3D
Post-production

Loris Di Pancrazio
loris.dipancrazio@gmail.com



ALTEREGO DIVANI S.R.L. a S.U.
Via gabbiano, 24 - Zona ind.le S. Scolastica
64013 Corropoli (TE) - Italy - C.F. P.IVA 01626610677
Tel. (+39) 0861/910585 - fax (+39) 0861/910930
info@alteregodivani.it
www.alteregodivani.it



ALTEREGO DIVANI S.R.L. a S.U.
64013 Corropoli (TE) - Italy
Via gabbiano, 24 - Zona ind.le S. Scolastica
Italy R.I. - C.F. - P.IVA 01626610677
Tel. (+39) 0861/910585 - fax (+39)0861/910930
info@alteregodivani
www.alteregodivani.it