



ALTEREGO DIVANI S.R.L. a S.U.
64013 Corropoli (TE) - Italy
Via gabiano, 24 - Zona ind.le S. Scolastica
Italy R.I. - C.F. - P.IVA 01626610677
Tel. (+39) 0861/910585 - fax (+39)0861/910930
info@alteregodivani
www.alteregodivani.it

Design like lifestyle

FUTURA COLLECTION

Innovation solution of design
for contemporary home

FUTURA COLLECTION

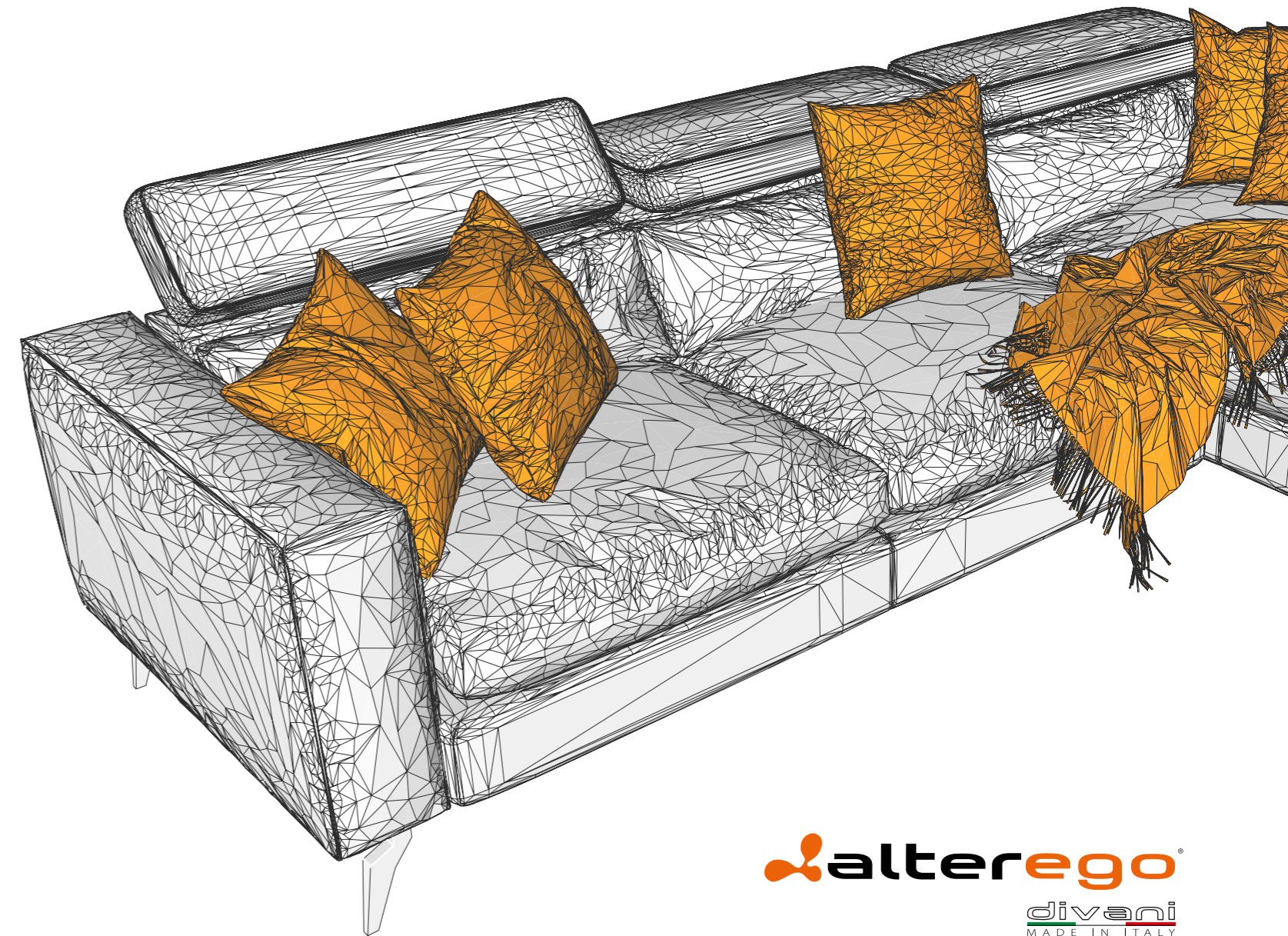

A grayscale background image of a large industrial building, likely a factory or warehouse, with a white car parked in front. The building has a sign that reads "alterego" above a large glass entrance. The sky is overcast.

CHI SIAMO

Creata nel 2006, con un'esperienza trentennale alle spalle, Alterego divani è specializzata nella produzione di divani, poltrone e letti di ogni tipologia. Imbottiti dalle linee classiche o avveniristiche, straordinaria qualità dei materiali e delle lavorazioni eseguite secondo l'ottica artigiana del Made in Italy. L'obiettivo dell'azienda è, infatti, soddisfare ogni richiesta offrendo qualità, funzionalità ed innovazione.

Created in 2006, with thirty years of experience behind him, Alterego sofas specializes in the production of sofas, armchairs and beds of all types. Upholstered furniture with classic or futuristic lines, extraordinary quality of materials and workmanship performed according to the artisan optic Made in Italy. The company's goal is; in fact, meet all requirements by offering quality, functionality and innovation.



MADE IN ITALY

“Made in Italy” è il simbolo che raffigura la cultura del bello, l’amore per l’arte e la filosofia del buon vivere. Non è un caso che sia divenuto il terzo marchio al mondo e il primo nel mondo della moda, del design, dell’architettura e dell’arredamento. Tutti i nostri prodotti sono caratterizzati da elevati standard di qualità e design ricercato che sono il frutto dell’impegno e della passione che vengono impiegati nella produzione di ciascun elemento.

“Made in Italy” is the symbol that represents the culture of beauty, the love for the art and philosophy of good living. It is no coincidence that it became the third brand in the world and the first in the world of fashion, design, architecture and interior design. All our products are characterized by high standards of quality and sleek design that are the result of ‘commitment and passion that are used in the production of each item.



EXPORT

Da oltre 10 anni Esportiamo i nostri prodotti all’estero riscuotendo un grande successo ed una continua richiesta. Oggi siamo presenti in tutto il territorio Nazionale, in Europa e, grazie a dei ultimi accordi, saremo presenti anche nei Paesi del Medio Oriente.

For over 10 years we export our products abroad with great success and a continuous demand. Today we are present all over the national territory, in Europe, thanks to some recent agreements, we will also be present in the Middle East countries.



Da noi il designer sei tu.

Un prodotto interamente fatto a mano che ti renderà partecipe nella sua personalizzazione in ogni singolo dettaglio.

With us, the designer is you.

A product entirely handmade that will make you participate in its personalization in every single detail.



RICHMOND
FISSO
pag. 12



DAMASCO
LETTO / RELAX
pag. 72



MABEL
FISSO / LETTO
pag. 146



ROCKY
FISSO / LETTO
pag. 208



SINGAPORE
FISSO
pag. 20



ZEUS
FISSO / LETTO
pag. 82



ELOISE
FISSO / LETTO
pag. 156



SHINE
FISSO / LETTO
pag. 216



TOKYO
FISSO
pag. 28



ODINO
FISSO / LETTO
pag. 92



STILOS
FISSO / LETTO
pag. 164



MIRA
FISSO / LETTO
pag. 224



NEW YORK
FISSO
pag. 36



THOR
FISSO / LETTO
pag. 102



LOIS
FISSO / LETTO
pag. 174



MARLEN
FISSO / LETTO
pag. 230



MANCHESTER
FISSO
pag. 44



NIZZA
FISSO / LETTO
pag. 112



SLIDE
FISSO / LETTO
pag. 182



CHANTAL
FISSO / LETTO
pag. 236



MIAMI
FISSO / RELAX
pag. 52



DUBAI
FISSO / LETTO
pag. 122



DAKAR
FISSO / LETTO
pag. 190



POLTRONE
pag. 244



PANAMA
FISSO / RELAX
pag. 62



REVERS
FISSO / LETTO
pag. 132



STEP
FISSO / LETTO
pag. 200



OPZIONI
MATERASSI
MECCANISMI
pag. 258

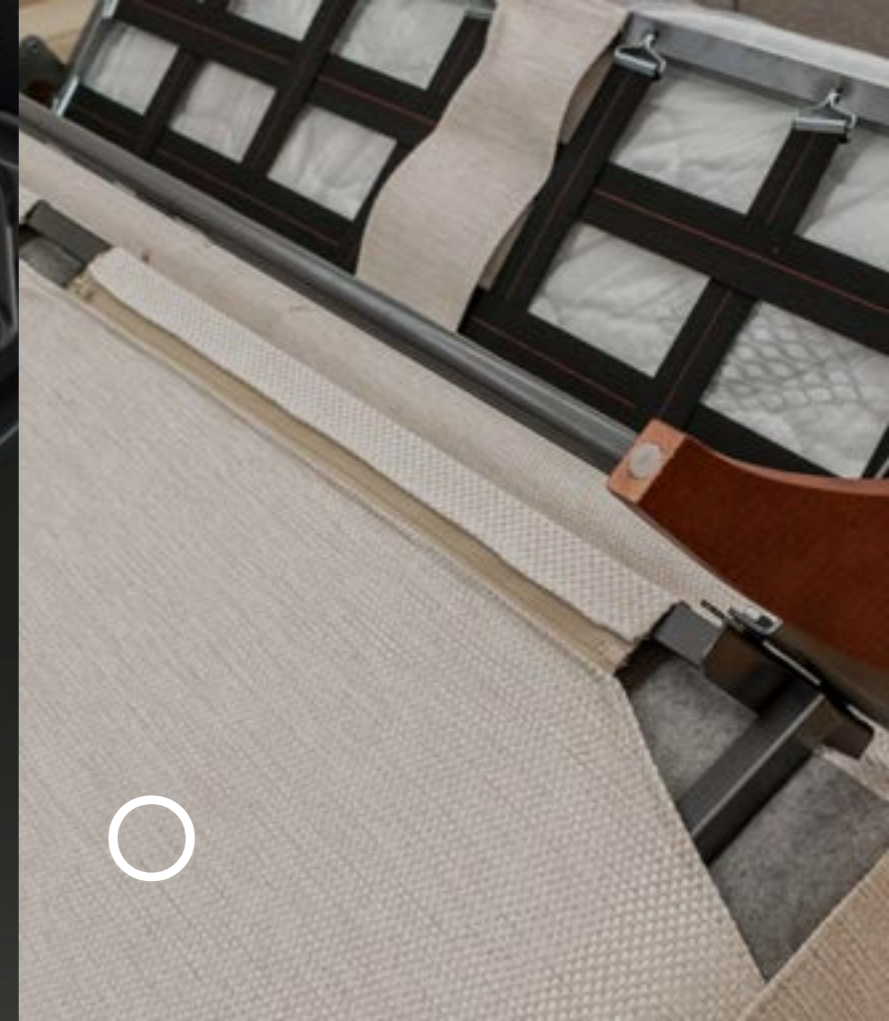



I particolari,
curati nei minimi dettagli,
rendono Alterego divani un marchio di
eccellenza per qualità e ricercatezza nei
materiali



The details,
make Alterego sofas a brand
of excellence for quality
and refinement in materials.



RICHMOND

Il divano Richmond risponde
a pieno alle esigenze di
spazio ed estetica degli
ambienti moderni.
The sofa Richmond responds
fully to the needs of space and
aesthetics of modern interiors.





16
RICHMOND /



I particolari
generano l'insieme.
The details generate
the whole.





STRUTTURA:
 Agglomerato di legno foderato con tessuto vellutino termoaccoppiato ad un sottile strato di poliuretano espanso.
IMBOTTITURE:
 Cuscini di seduta in gomma doppia densità 35/28 kg/mc e fibra sintetica 200 g/mc.
 Cuscini di spalliera densità super soft SS 18 kg/mc.
RIVESTIMENTO:
 Interamente sfoderabile.
 Per la variante ecopelle o pelle sfoderabile solo la cuscineria.

STRUCTURE:
 Wooden agglomerate lined with fine velvet fabric thermocoupled to a thin layer of polyurethane foam.
CUSHIONS PADDING:
 Seat cushions rubber in double density 35/28 kg/mc and synthetic fiber 200 g/mc.
 Back cushions density super soft SS 18 kg/mc.
COVER:
 Completely removable.
 In artificial leather or leather removable only cushions.

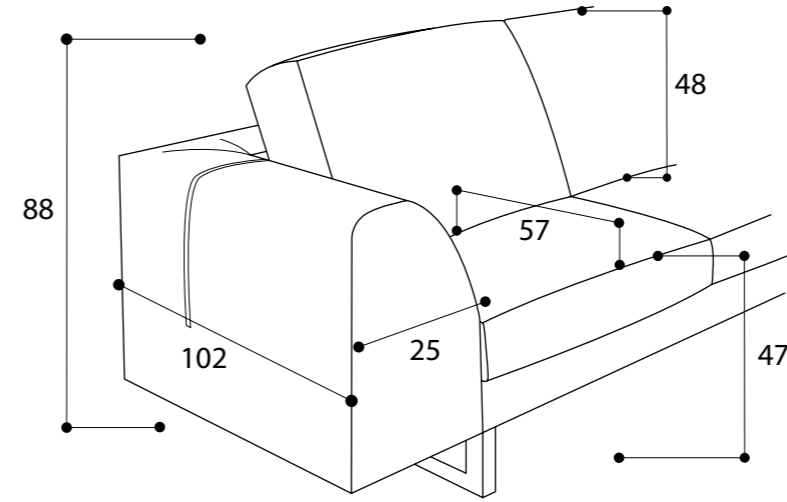

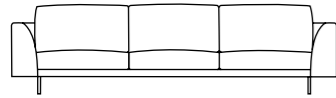
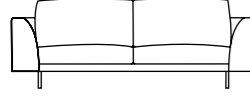
Disponibile con piedini /
 available with feet /

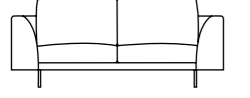

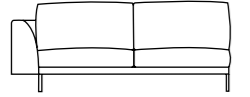
Dimensione con braccioli tipo / Size with armrests type		A
	4 posti fisso 4 places fix	270
	3 posti max fisso 3,5 places fix	244
	3 posti fisso 3 places fix	234
	Intermedio fisso 2,5 places fix	224
	2 posti fisso 2 places fix	204
	4 posti laterale fisso - bracciolo DX o SX 4 lateral places - armrest DX o SX	245
	3 posti max laterale fisso - bracciolo DX o SX 3,5 lateral places - armrest DX o SX	219

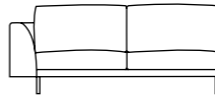
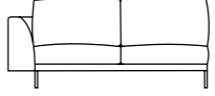
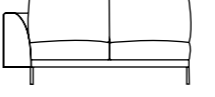
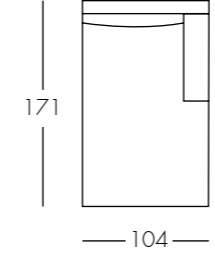
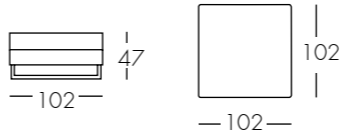
Dimensione con braccioli tipo / Size with armrests type		A
	3 posti laterale fisso - bracciolo DX o SX 3 lateral places fix - armrest DX o SX	209
	Intermedio laterale fisso - bracciolo DX o SX 2,5 lateral places fix - armrest right or left	199
	2 posti laterale fisso - bracciolo DX o SX 2 lateral places fix - armrest DX o SX	179
	Chaiselongue laterale fissa bracciolo DX o SX Lateral fixed chaiselongue armrest DX o SX	104
	Pouff fisso/contenitore Fixed/stored pouf	



Una presenza che da sola è
protagonista nel salone.
A presence that alone is the
protagonist of the environment.





25
SINGAPORE /
3P + CHAISERLONGUE

STRUTTURA:
 Agglomerato di legno foderato con tessuto vellutino termoaccoppiato ad un sottile strato di poliuretano espanso.
IMBOTTITURE:
 Cuscini di seduta in gomma doppia densità 35/28 kg/mc e fibra sintetica 200 g/mc.
 Cuscini di spalliera in fiocco ricoperto di fibra sintetica.
RIVESTIMENTO:
 Interamente sfoderabile.
 Per la variante ecopelle o pelle sfoderabile solo la cuscineria.

STRUCTURE:
 Wooden agglomerate lined with fine velvet fabric thermocoupled to a thin layer of polyurethane foam.
CUSHIONS PADDING:
 Seat cushions rubber in double density 35/28 kg/mc and synthetic fiber 200 g/mc. Back cushions covered in synthetic staple fiber.
COVER:
 Completely removable.
 In artificial leather or leather removable only cushions.



Disponibile con piedini / available with feet /

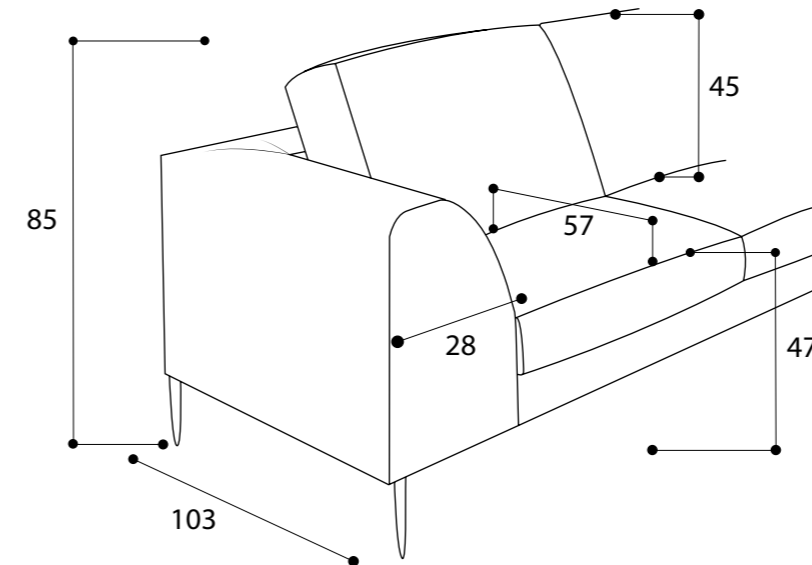

Dimensione con braccioli tipo / Size with armrests type

Dimensione con braccioli tipo / Size with armrests type		A
	3 posti max fisso 3,5 places fix	246
	3 posti fisso 3 places fix	236
	Intermedio fisso 2,5 places fix	226
	2 posti fisso 2 places fix	206
	3 posti max laterale fisso - bracciolo DX o SX 3,5 lateral places - armrest DX o SX	218
	3 posti laterale fisso - bracciolo DX o SX 3 lateral places fix - armrest DX o SX	208

Dimensione con braccioli tipo / Size with armrests type

Dimensione con braccioli tipo / Size with armrests type		A
	Intermedio laterale fisso - bracciolo DX o SX 2,5 lateral places fix - armrest right or left	198
	2 posti laterale fisso - bracciolo DX o SX 2 lateral places fix - armrest DX o SX	178
	Chaiselongue laterale fissa bracciolo DX o SX Lateral fixed chaiselongue armrest DX o SX	104
	Pouff fisso/contenitore Fixed/storaged pouf	47 103

TOKYO



29
TOKYO /
3P + CHAISÉLONGUE



30
TOKYO /

Estremamente comodo
e perfetto per ogni ambiente.
Extremely comfortable and
perfect for any environment.



31
TOKYO / 3P



STRUTTURA:
 Agglomerato di legno foderato con tessuto vellutino termoaccoppiato ad un sottile strato di poliuretano espanso.
IMBOTTITURE:
 Cuscini di seduta in gomma doppia densità 35/28 kg/mc e fibra sintetica 200 g/mc.
 Cuscini di spalliera densità super soft SS 18 kg/mc.
RIVESTIMENTO:
 Interamente sfoderabile.
 Per la variante ecopelle o pelle sfoderabile solo la cuscineria.

STRUCTURE:
 Wooden agglomerate lined with fine velvet fabric thermocoupled to a thin layer of polyurethane foam.
CUSHIONS PADDING:
 Seat cushions rubber in double density 35/28 kg/mc and synthetic fiber 200 g/mc.
 Back cushions density super soft SS 18 kg/mc.
COVER:
 Completely removable.
 In artificial leather or leather removable only cushions.



Disponibile con piedini / available with feet /

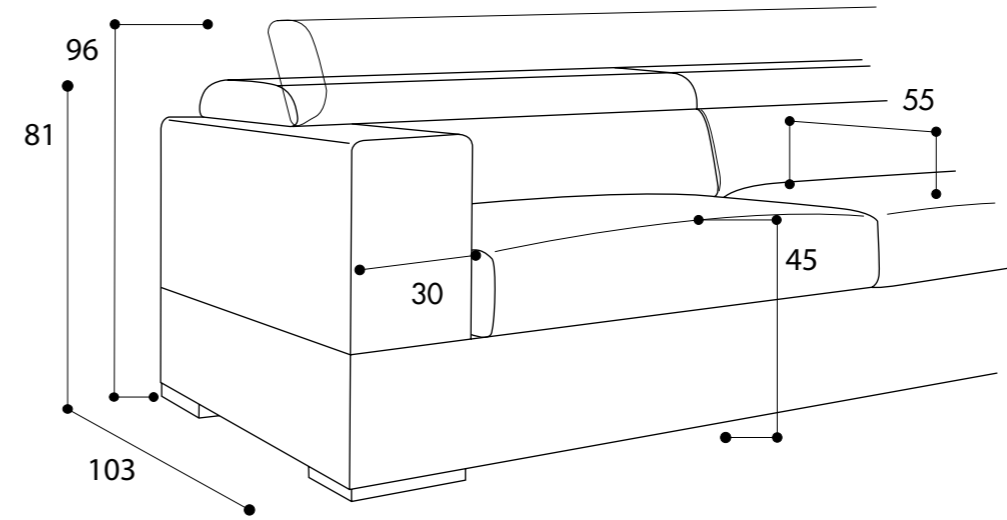

Dimensione con braccioli tipo / Size with armrests type		A
	3 posti max fisso 3,5 places fix	244
	3 posti fisso 3 places fix	224
	Intermedio fisso 2,5 places fix	204
	2 posti fisso 2 places fix	184
	3 posti max laterale fisso - bracciolo DX o SX 3,5 lateral places - armrest DX o SX	214
	3 posti laterale fisso - bracciolo DX o SX 3 lateral places fix - armrest DX o SX	194

Dimensione con braccioli tipo / Size with armrests type		A
	Intermedio laterale fisso - bracciolo DX o SX 2,5 lateral places fix - armrest right or left	174
	2 posti laterale fisso - bracciolo DX o SX 2 lateral places fix - armrest DX o SX	154
	Chaiselongue laterale fissa bracciolo DX o SX Lateral fixed chaiselongue armrest DX o SX	104
 	Pouff fisso/contenitore Fixed/stored pouf	

NEW YORK



I piedini in metallo arricchiscono
l'estetica del divano
donandogli un senso di leggerezza.
The metal feet enrich the aesthetics of the
sofa giving it a sense of lightness.





STRUTTURA:
 Agglomerato di legno foderato con tessuto vellutino termoaccoppiato ad un sottile strato di poliuretano espanso.
IMBOTTITURE:
 Cuscini di seduta in gomma doppia densità 35/28 kg/mc e fibra sintetica 200 g/mc.
 Cuscini di spalliera densità super soft SS 18 kg/mc.
RIVESTIMENTO:
 Interamente sfoderabile.
 Per la variante ecopelle o pelle sfoderabile solo la cuscineria.

STRUCTURE:
 Wooden agglomerate lined with fine velvet fabric thermocoupled to a thin layer of polyurethane foam.
CUSHIONS PADDING:
 Seat cushions rubber in double density 35/28 kg/mc and synthetic fiber 200 g/mc.
 Back cushions density super soft SS 18 kg/mc.
COVER:
 Completely removable.
 In artificial leather or leather removable only cushions.



Disponibile con piedini / available with feet /

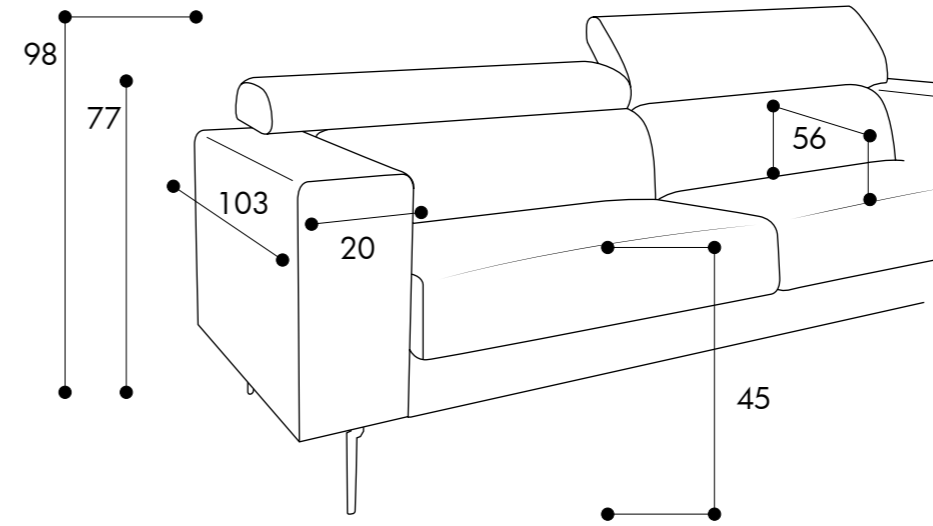

Dimensione con braccioli tipo / Size with armrests type

Dimensione con braccioli tipo / Size with armrests type		A
	3 posti max fisso 3,5 places fix	230
	3 posti fisso 3 places fix	210
	Intermedio fisso 2,5 places fix	190
	3 posti max laterale fisso - bracciolo DX o SX 3,5 lateral places - armrest DX o SX	205
	3 posti laterale fisso - bracciolo DX o SX 3 lateral places fix - armrest DX o SX	185
	Intermedio laterale fisso - bracciolo DX o SX 2,5 lateral places fix - armrest right or left	165

Dimensione con braccioli tipo / Size with armrests type		A
	Chaiselongue laterale fissa bracciolo DX o SX lateral fixed chaiselongue armrest DX o SX	103
	Pouff fisso/contenitore Fixed/storaged pouf	

MANCHESTER



Il comfort è garantito dai generosi braccioli
e dal poggiatesta regolabile.
The comfort is guaranteed by the generous arms
and the adjustable headrest.



Estremamente comodo
e perfetto per ogni ambiente.
Extremely comfortable and
perfect for any environment.



STRUTTURA:
 Agglomerato di legno foderato con tessuto vellutino termoaccoppiato ad un sottile strato di poliuretano espanso.
IMBOTTITURE:
 Cuscini di seduta in gomma doppia densità 35/28 kg/mc e fibra sintetica 200 g/mc.
 Cuscini di spalliera densità super soft SS 18 kg/mc.
RIVESTIMENTO:
 Interamente sfoderabile.
 Per la variante ecopelle o pelle sfoderabile solo la cuscineria.

STRUCTURE:
 Wooden agglomerate lined with fine velvet fabric thermocoupled to a thin layer of polyurethane foam.
CUSHIONS PADDING:
 Seat cushions rubber in double density 35/28 kg/mc and synthetic fiber 200 g/mc.
 Back cushions density super soft SS 18 kg/mc.
COVER:
 Completely removable.
 In artificial leather or leather removable only cushions.



Disponibile con piedini / available with feet /

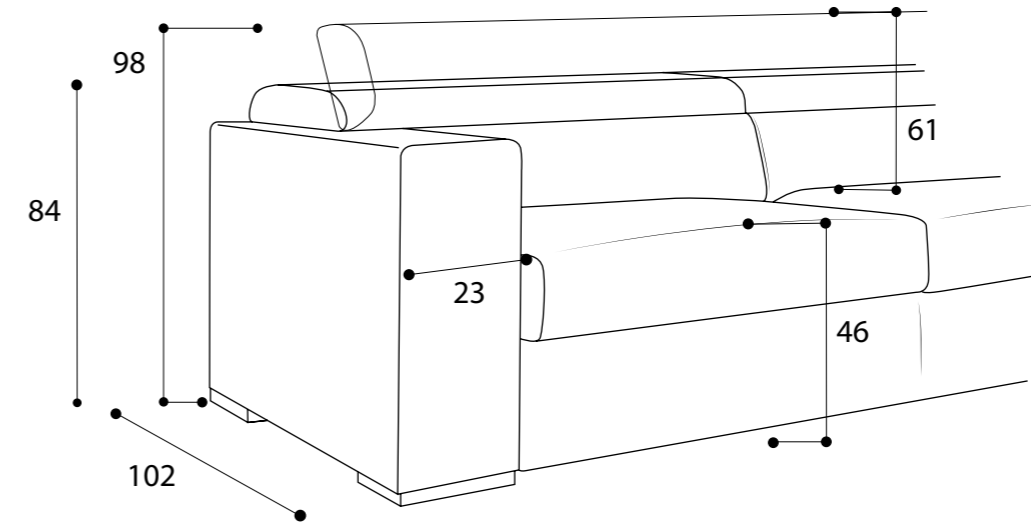

Dimensione con braccioli tipo / Size with armrests type

A

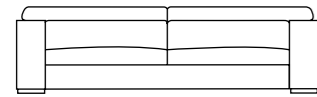

3 posti max fisso
 3,5 places fix

230

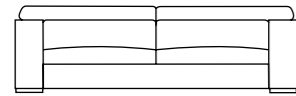

3 posti fisso
 3 places fix

210



Intermedio fisso
 2,5 places fix

190

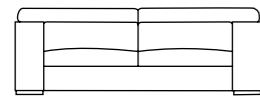

2 posti fisso
 2 places fix

170



3 posti max laterale fisso -
 bracciolo DX o SX
 3,5 lateral places - armrest
 DX o SX

207

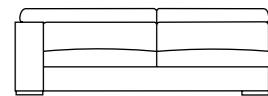

3 posti laterale fisso - bracciolo
 DX o SX
 3 lateral places fix - armrest DX
 o SX

187

Dimensione con braccioli tipo / Size with armrests type

A

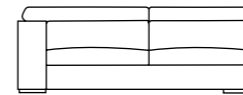

Intermedio laterale fisso -
 bracciolo DX o SX
 2,5 lateral places fix - armrest
 right or left

167



2 posti laterale fisso -
 bracciolo DX o SX
 2 lateral places fix -
 armrest DX o SX

147

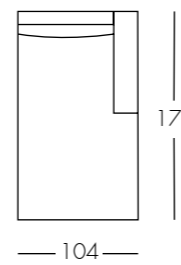

Chaiselongue laterale fissa
 bracciolo DX o SX
 Lateral fixed chaiselongue
 armrest DX o SX

104

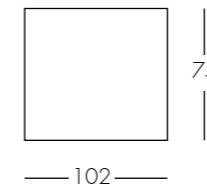
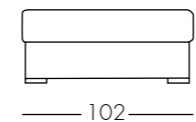

Pouff fisso/contenitore
 Fixed/storaged pouf



Un divano funzionale che
coniuga bellezza e comfort.
A functional sofa that combines
beauty and comfort.



54
MIAMI /



La serenità nasce
dall'equilibrio delle forme.
The serenity is born from the
balance of the forms.



STRUTTURA:
 Agglomerato di legno foderato con tessuto vellutino termoaccoppiato ad un sottile strato di poliuretano espanso.
IMBOTTITURE:
 Cuscini di seduta in gomma densità 30 kg/mc e fibra sintetica 200 g/mc.
 Cuscini di spalliera densità 22 kg/mc.
RIVESTIMENTO:
 Interamente sfoderabile.
 Per la variante ecopelle o pelle sfoderabile solo la cuscinatura.

STRUCTURE:
 Wooden agglomerate lined with fine velvet fabric thermocoupled to a thin layer of polyurethane foam.
CUSHIONS PADDING:
 Seat cushions rubber density 30 kg/mc and synthetic fiber 200 g/mc.
 Back cushions density 22 kg/mc.
COVER:
 Completely removable.
 In artificial leather or leather removable only cushions.



Disponibile con piedini / available with feet /

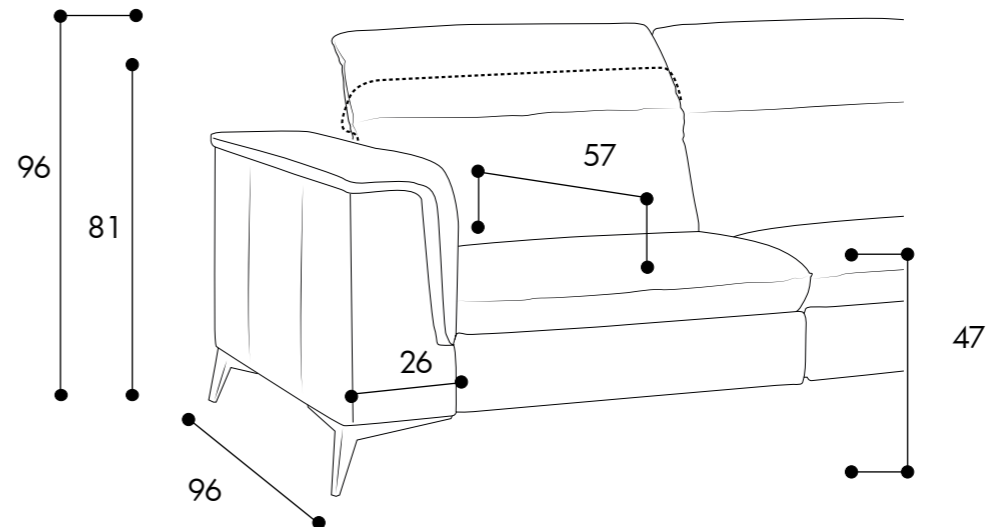
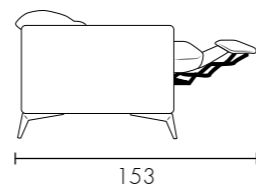

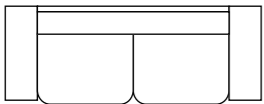
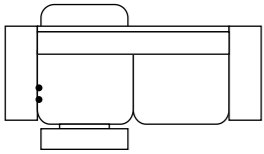
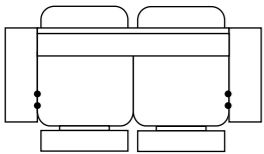
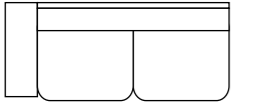
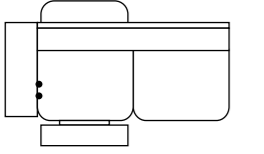
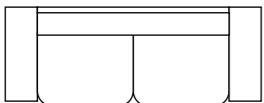

Dimensione con braccioli tipo / Size with armrests type

A

	3 posti fisso 3 places fix	214
	3 posti / 1 recliner elettrico Sx o Dx 3 places / 1 electric recliner Dx o Sx	216
	3 posti / 2 recliner elettrico Sx o Dx 3 places / 2 electric recliner Dx o Sx	218
	3 posti laterale fisso - bracciolo DX o SX 3 lateral places fix - armrest DX o SX	188
	3 posti laterale con recliner elettrico - bracciolo DX o SX 3 lateral places with electric recliner - armrest DX o SX	190
	2 posti fisso 2 places fix	180

Dimensione con braccioli tipo / Size with armrests type

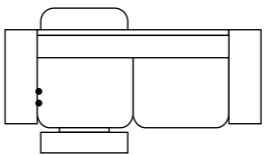
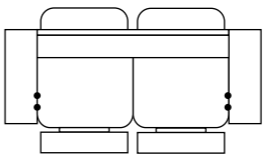
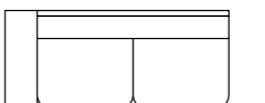
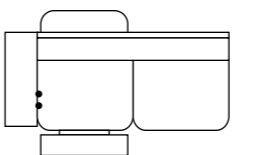
A

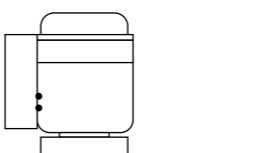
	2 posti / 1 recliner elettrico Sx o Dx 2 places / 1 electric recliner Dx o Sx	183
	2 posti / 2 recliner elettrico Sx o Dx 2 places / 2 electric recliner Dx o Sx	186
	2 posti laterale fisso - bracciolo DX o SX 2 lateral places fix - armrest DX o SX	154
	2 posti laterale con recliner elettrico - bracciolo DX o SX 2 lateral places with electric recliner - armrest DX o SX	157
	Poltrona laterale maxi - bracciolo DX o SX Armchair maxi lateral fix - armrest DX o SX	107
	Poltrona laterale maxi con recliner elettrico - bracciolo DX o SX Armchair maxi lateral with electric recliner - armrest DX o SX	109

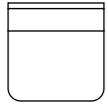
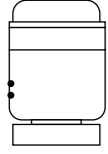
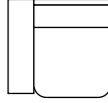
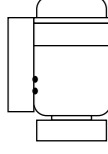
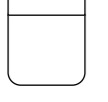
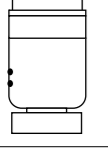
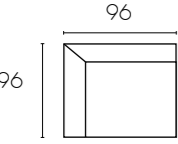
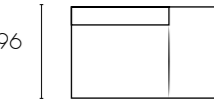
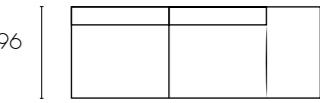
Dimensione con braccioli tipo / Size with armrests type		A
	Poltrona maxi senza bracciolo Armchair maxi without armrest	81
	Poltrona maxi senza bracciolo con recliner elettrico Armchair maxi without armrest with electric recliner	83
	Poltrona laterale - bracciolo DX o SX Armchair lateral fix - armrest DX o SX	90
	Poltrona laterale con recliner elettrico bracciolo DX o SX Armchair lateral with electric recliner - armrest DX o SX	93
	Poltrona senza bracciolo Armchair without armrest	64
	Poltrona senza bracciolo con recliner elettrico Armchair without armrest with electric recliner	67
	Angolo quadrato (poggiatesta fissi) Square corner (fixed headrests)	96
	Poltrona terminale terminal armchair	123
	2 posti terminale 2 places terminal	187

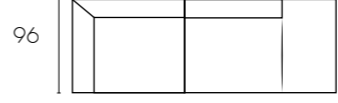
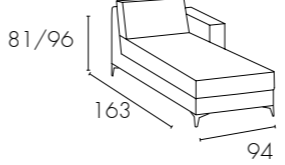
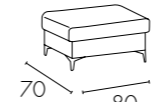
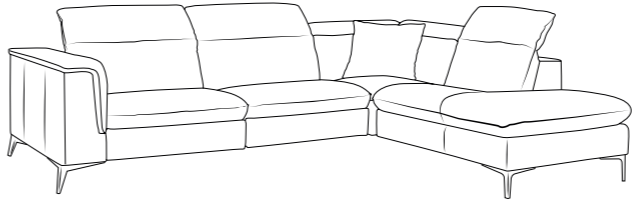
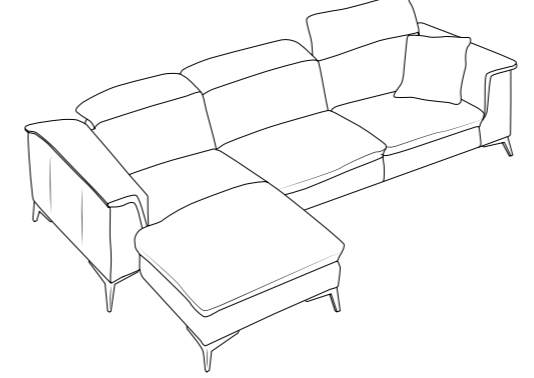
Dimensione con braccioli tipo / Size with armrests type		A					
	Angolo / poltrona terminale Corner / terminal armchair	219					
	Chaiselongue laterale fissa bracciolo DX o SX Lateral fixed chaiselongue armrest DX o SX	163					
	Pouff fisso Fixed pouf						
	3 posti laterale + angolo / poltrona terminale 3 lateral places + Corner / terminal armchair	284					
	<table border="0"> <tr> <td> <ul style="list-style-type: none"> fisso fix </td> <td></td> </tr> <tr> <td> <ul style="list-style-type: none"> con 1 recliner elettrica with 1 electric recliner </td> <td>286</td> </tr> <tr> <td> <ul style="list-style-type: none"> con 2 recliner elettrica with 2 electric recliner </td> <td>288</td> </tr> </table>	<ul style="list-style-type: none"> fisso fix 		<ul style="list-style-type: none"> con 1 recliner elettrica with 1 electric recliner 	286	<ul style="list-style-type: none"> con 2 recliner elettrica with 2 electric recliner 	288
<ul style="list-style-type: none"> fisso fix 							
<ul style="list-style-type: none"> con 1 recliner elettrica with 1 electric recliner 	286						
<ul style="list-style-type: none"> con 2 recliner elettrica with 2 electric recliner 	288						
	3 posti laterale + chaiselongue 3 lateral places + chaiselongue	282					
	<table border="0"> <tr> <td> <ul style="list-style-type: none"> fisso fix </td> <td></td> </tr> <tr> <td> <ul style="list-style-type: none"> con 1 recliner elettrica with 1 electric recliner </td> <td>284</td> </tr> <tr> <td> <ul style="list-style-type: none"> con 2 recliner elettrica with 2 electric recliner </td> <td>286</td> </tr> </table>	<ul style="list-style-type: none"> fisso fix 		<ul style="list-style-type: none"> con 1 recliner elettrica with 1 electric recliner 	284	<ul style="list-style-type: none"> con 2 recliner elettrica with 2 electric recliner 	286
<ul style="list-style-type: none"> fisso fix 							
<ul style="list-style-type: none"> con 1 recliner elettrica with 1 electric recliner 	284						
<ul style="list-style-type: none"> con 2 recliner elettrica with 2 electric recliner 	286						

N.B. Le versioni con recliner presentano 2 piedini di sostegno per il peso
The versions with recliner have 2 feet of support for the weight



PANAMA

63
PANAMA /

L'efficienza nella morbidezza.
The efficiency in the softness.

Coniuga bellezza,
funzionalità e comfort.
The perfect coniugation of beauty,
functionality and comfort.



Si caratterizza per
componibilità, comfort ed estetica.
It is characterized by
modular lines, comfort and modern
aesthetics.



STRUTTURA:
 Agglomerato di legno foderato con tessuto vellutino termoaccoppiato ad un sottile strato di poliuretano espanso.
IMBOTTITURE:
 Cuscini di seduta in gomma densità 30 kg/mc e fibra sintetica 200 g/mc.
 Cuscini di spalliera densità 22 kg/mc.
RIVESTIMENTO:
 Interamente sfoderabile.
 Per la variante ecopelle o pelle sfoderabile solo la cuscineria.

STRUCTURE:
 Wooden agglomerate lined with fine velvet fabric thermocoupled to a thin layer of polyurethane foam.
CUSHIONS PADDING:
 Seat cushions rubber density 30 kg/mc and synthetic fiber 200 g/mc.
 Back cushions density 22 kg/mc.
COVER:
 Completely removable.
 In artificial leather or leather removable only cushions.



Disponibile con piedini /
 available with feet /

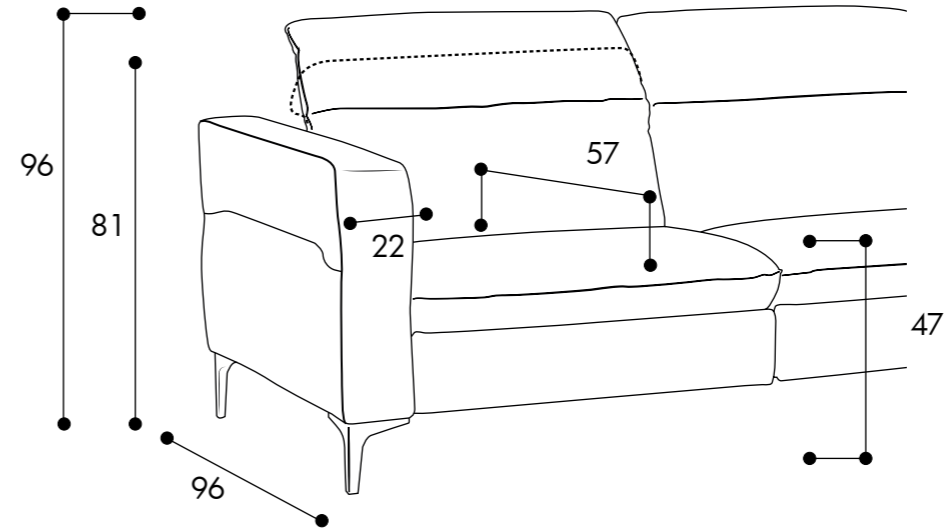
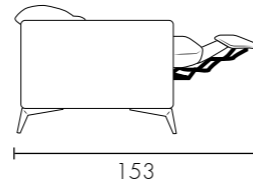

Dimensione con braccioli tipo / Size with armrests type

A

	3 posti fisso 3 places fix	206
	3 posti / 1 recliner elettrico Sx o Dx 3 places / 1 electric recliner Dx o Sx	208
	3 posti / 2 recliner elettrico Sx o Dx 3 places / 2 electric recliner Dx o Sx	210
	3 posti laterale fisso - bracciolo DX o SX 3 lateral places fix - armrest DX o SX	184
	3 posti laterale con recliner elettrico - bracciolo DX o SX 3 lateral places with electric recliner - armrest DX o SX	186
	2 posti fisso 2 places fix	172

Dimensione con braccioli tipo / Size with armrests type

A

	2 posti / 1 recliner elettrico Sx o Dx 2 places / 1 electric recliner Dx o Sx	175
	2 posti / 2 recliner elettrico Sx o Dx 2 places / 2 electric recliner Dx o Sx	178
	2 posti laterale fisso - bracciolo DX o SX 2 lateral places fix - armrest DX o SX	150
	2 posti laterale con recliner elettrico - bracciolo DX o SX 2 lateral places with electric recliner - armrest DX o SX	153
	Poltrona laterale maxi - bracciolo DX o SX Armchair maxi lateral fix - armrest DX o SX	103
	Poltrona laterale maxi con recliner elettrico bracciolo DX o SX Armchair maxi lateral with electric recliner - armrest DX o SX	106

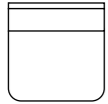
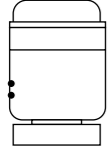
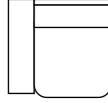
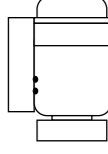
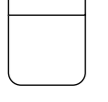
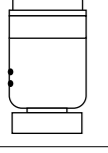
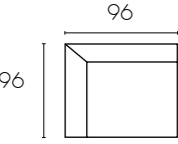
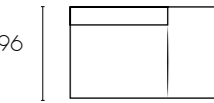
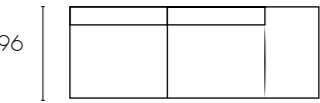
Dimensione con braccioli tipo / Size with armrests type		A
	Poltrona maxi senza bracciolo Armchair maxi without armrest	81
	Poltrona maxi senza bracciolo con recliner elettrico Armchair maxi without armrest with electric recliner	83
	Poltrona laterale - bracciolo DX o SX Armchair lateral fix - armrest DX o SX	86
	Poltrona laterale con recliner elettrico bracciolo DX o SX Armchair lateral with electric recliner - armrest DX o SX	89
	Poltrona senza bracciolo Armchair without armrest	64
	Poltrona senza bracciolo con recliner elettrico Armchair without armrest with electric recliner	67
	Angolo quadrato (poggiatesta fissi) Square corner (fixed headrests)	96
	Poltrona terminale terminal armchair	123
	2 posti terminale 2 places terminal	187

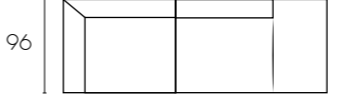
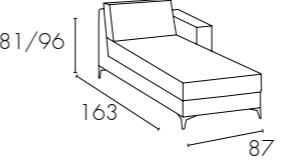
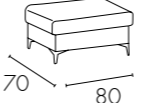
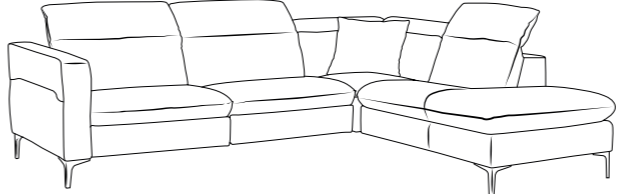
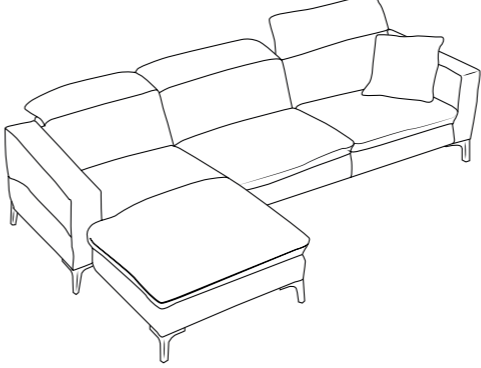
Dimensione con braccioli tipo / Size with armrests type		A					
	Angolo / poltrona terminale Corner / terminal armchair	219					
	Chaiselongue laterale fissa bracciolo DX o SX Lateral fixed chaiselongue armrest DX o SX	163					
	Pouff fisso Fixed pouf						
	3 posti laterale + angolo / poltrona terminale 3 lateral places + Corner / terminal armchair	280					
	<table border="0"> <tr> <td> <ul style="list-style-type: none"> fisso fix </td> <td></td> </tr> <tr> <td> <ul style="list-style-type: none"> con 1 recliner elettrica with 1 electric recliner </td> <td>282</td> </tr> <tr> <td> <ul style="list-style-type: none"> con 2 recliner elettrica with 2 electric recliner </td> <td>284</td> </tr> </table>	<ul style="list-style-type: none"> fisso fix 		<ul style="list-style-type: none"> con 1 recliner elettrica with 1 electric recliner 	282	<ul style="list-style-type: none"> con 2 recliner elettrica with 2 electric recliner 	284
<ul style="list-style-type: none"> fisso fix 							
<ul style="list-style-type: none"> con 1 recliner elettrica with 1 electric recliner 	282						
<ul style="list-style-type: none"> con 2 recliner elettrica with 2 electric recliner 	284						
	3 posti laterale + chaiselongue 3 lateral places + chaiselongue	271					
	<table border="0"> <tr> <td> <ul style="list-style-type: none"> fisso fix </td> <td></td> </tr> <tr> <td> <ul style="list-style-type: none"> con 1 recliner elettrica with 1 electric recliner </td> <td>273</td> </tr> <tr> <td> <ul style="list-style-type: none"> con 2 recliner elettrica with 2 electric recliner </td> <td>275</td> </tr> </table>	<ul style="list-style-type: none"> fisso fix 		<ul style="list-style-type: none"> con 1 recliner elettrica with 1 electric recliner 	273	<ul style="list-style-type: none"> con 2 recliner elettrica with 2 electric recliner 	275
<ul style="list-style-type: none"> fisso fix 							
<ul style="list-style-type: none"> con 1 recliner elettrica with 1 electric recliner 	273						
<ul style="list-style-type: none"> con 2 recliner elettrica with 2 electric recliner 	275						

N.B. Le versioni con recliner presentano 2 piedini di sostegno per il peso
The versions with recliner have 2 feet of support for the weight

DAMASCO



Coniuga bellezza,
funzionalità e comfort.
The perfect coniugation of beauty,
functionality and comfort.



Dettagli di design contribuiscono
all'identificazione di un'estetica
contemporanea.
Design details contribute in the
identification of a
contemporary aesthetic.



74
DAMASCO /



75
DAMASCO /



Unico nel suo genere,
unisce qualità e comfort.
Unique in his category, combine
quality and comfort.



Divano letto con rete elettrosaldata e cinghie elastiche,
MATERASSO MEDICAL H18 CM STANDARD.

Completamente sfoderabile con rivestimento in tessuto. Composto da elementi smontabili per facilitare il trasporto e la sfoderabilità.
Montaggio degli elementi con sistema a baionetta. Struttura: agglomerato di legno foderato con tessuto vellutino termoaccoppiato ad un sottile strato di poliuretano espanso. Imbottitura: schienali e sedute in poliuretano espanso indeformabile avvolte con falda siliconata.
Vano porta guanciali su retro schienale.

Sofa bed with electrowelded bed case, elastic belts and
MATTRESS MEDICAL H18 CM STANDARD.

Fully removable covers for fabric upholstery.
Composed by disassembled pieces for an easy transportation or cover removal.
Assembly of pieces by metal sliding-rail brackets. Structure: wooden agglomerate lined with fine velvet fabric thermocoupled to a thin layer of polyurethane foam.
Filling: back and seat cushions in indeformable polyurethane foam, silicone coated.
Pillow compartment on sofa back.

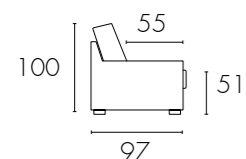

A
26 cm

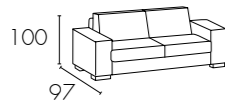
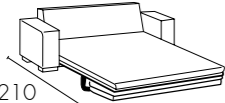
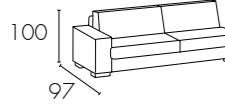
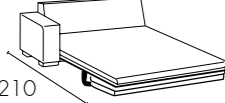
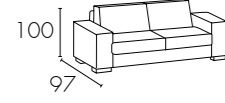
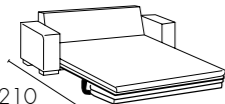
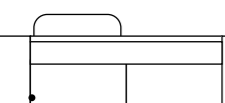

Dimensione con braccioli tipo / Size with armrests type **A**

	3 posti maxi fisso 3,5 places fix	240
	3 posti maxi letto 3,5 places bed Materasso cm 160 x 190 x 18 Mattress cm 160 x 190 x 18	232
	3 posti maxi laterale - bracciolo DX o SX 3,5 lateral places - armrest DX o SX	212
	3 posti maxi laterale letto bracciolo DX o SX 3,5 lateral places bed armrest DX o SX Materasso cm 160 x 190 x 18 Mattress cm 160 x 190 x 18	206
	3 posti fisso 3 places fix	216
	3 posti letto 3 places bed Materasso cm 140 x 190 x 18 Mattress cm 140 x 190 x 18	212
	3 posti / 1 reclinatore elettrico Sx o Dx 3 places / 1 electric recliner Dx o Sx	216

DAMASCO

Dimensione con braccioli tipo / Size with armrests type **A**

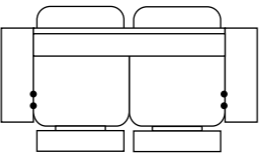
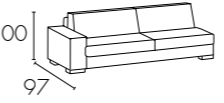
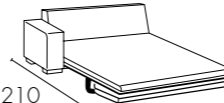
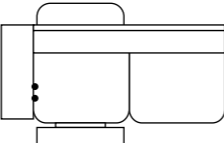
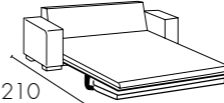
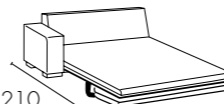
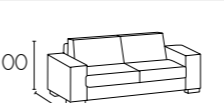
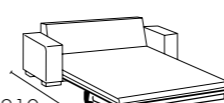
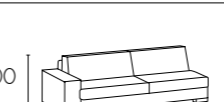
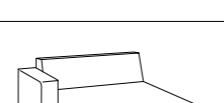
	3 posti / 2 reclinatore elettrico Sx o Dx 3 places / 2 electric recliner Dx o Sx	216
	3 posti laterale fisso - bracciolo DX o SX 3 lateral places fix - armrest DX o SX	190
	3 posti laterale letto bracciolo DX o SX 3 lateral places bed armrest DX o SX Materasso cm 140 x 190 x 18 Mattress cm 140 x 190 x 18	186
	3 posti laterale con reclinatore elettrico - bracciolo DX o SX 3 lateral places with electric recliner - armrest DX o SX	190
	Intermedio letto 2,5 places bed Materasso cm 120 x 190 x 18 Mattress cm 120 x 190 x 18	192
	Intermedio laterale letto bracciolo DX o SX 2,5 lateral places bed armrest DX o SX Materasso cm 120 x 190 x 18 Mattress cm 120 x 190 x 18	166
	2 posti fisso 2 places fix	180
	2 posti letto 2 places bed Materasso cm 100 x 190 x 18 Mattress cm 100 x 190 x 18	172
	2 posti laterale fisso - bracciolo DX o SX 2 lateral places fix - armrest DX o SX	154
	2 posti laterale letto bracciolo DX o SX 2 lateral places bed armrest DX o SX Materasso cm 100 x 190 x 18 Mattress cm 100 x 190 x 18	146

Dimensione con braccioli tipo / Size with armrests type

A

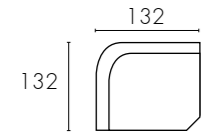

Angolo tondo
Rounding corner

132

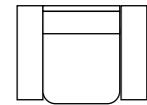

Poltrona fissa

116

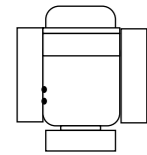

Poltrona con 1 recliner elettrica

116

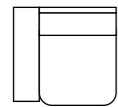

Poltrona laterale - bracciolo DX o SX
Armchair lateral fix - armrest DX o SX

90

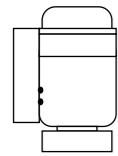

Poltrona laterale con recliner elettrico
bracciolo DX o SX
Armchair lateral with electric recliner -
armrest DX o SX

90



Poltrona senza bracciolo
Armchair without armrest

64

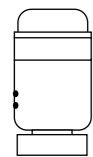

Poltrona senza bracciolo
con recliner elettrico
Armchair without armrest
with electric recliner

64

Dimensione con braccioli tipo / Size with armrests type

A

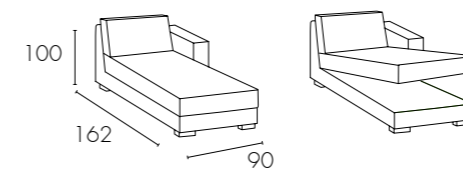

Chaiselongue laterale fissa / apribile
bracciolo DX o SX
Lateral fixed chaiselongue
armrest DX o SX

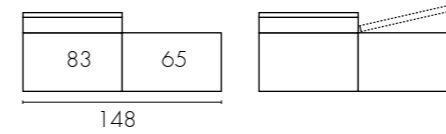

Terminale con pouff
Terminal with pouf

148



Disponibile con piedini /
available with feet /

N.B. Le versioni con recliner presentano 2 piedini di sostegno per il peso
The versions with recliner have 2 feet of support for the weight



ZEUS



84
ZEUS /



Dettagli di design contribuiscono
all'identificazione di un'estetica
contemporanea.
Design details contribute in the
identification of a
contemporary aesthetic.



86
ZEUS /
3P + CHAISERLONGUE
ZEUS / POLTRONA

Lo spazio prende una nuova
forma con
il morbido schienale e i pog-
giatesta reclinabili.
The space has a new shape
with the soft backrest and re-
clining headrest.



Divano letto con rete elettrosaldata e cinghie elastiche, materasso H 13 cm.
 Completamente sfoderabile con rivestimento in tessuto. Composto da elementi smontabili per facilitare il trasporto e la sfoderabilità.
 Montaggio degli elementi con sistema a baionetta. Struttura: agglomerato di legno foderato con tessuto vellutino termoaccoppiato ad un sottile strato di poliuretano espanso. Imbottitura: schienali e sedute in poliuretano espanso indeformabile avvolte con falda siliconata.
 Vano porta guanciali su retro schienale.

Sofa bed with electrowelded bed case, elastic belts and mattress H 13 cm .
 Fully removable covers for fabric upholstery.
 Composed by disassembled pieces for an easy transportation or cover removal.
 Assembly of pieces by metal sliding-rail brackets. Structure: wooden agglomerate lined with fine velvet fabric thermocoupled to a thin layer of polyurethane foam.
 Filling: back and seat cushions in indeformable polyurethane foam, silicone coated.
 Pillow compartment on sofa back.

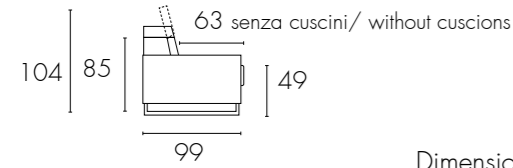

Dimensione con braccioli tipo / Size with armrests type

Dimensione con braccioli tipo / Size with armrests type		A
	3 posti max fisso 3,5 places fix	222
	3 posti letto 3 places bed Materasso cm 160 x 197 Mattress cm 160 x 197	212
	3 posti fisso 3 places fix	202
	3 posti letto 3 places bed Materasso cm 140 x 197 Mattress cm 140 x 197	212
	Intermedio fisso 2,5 places fix	182
	Intermedio letto 2,5 places bed Materasso cm 120 x 197 Mattress cm 120 x 197	212
	2 posti fisso 2 places fix	162
	2 posti letto 2 places bed Materasso cm 100 x 197 Mattress cm 100 x 197	212
	Poltrona letto Armchair bed Materasso cm 70 x 197 Mattress cm 70 x 197	132
	Poltrona fissa Armchair fix	102
	3 posti max laterale fisso - bracciolo DX o SX 3,5 lateral places - armrest DX o SX	201
	3 posti max laterale letto - bracciolo DX o SX 3,5 lateral places bed - armrest DX o SX	212
	3 posti laterale fisso - bracciolo DX o SX 3 lateral places fix - armrest DX o SX	181
	3 posti laterale letto - bracciolo DX o SX 3 lateral places bed - armrest DX o SX	212
	Intermedio laterale fisso - bracciolo DX o SX 2,5 lateral places fix - armrest right or left	161
	Intermedio letto - bracciolo DX o SX 2,5 lateral places bed - armrest DX o SX	212

Dimensione con braccioli tipo / Size with armrests type

Dimensione con braccioli tipo / Size with armrests type		A
	2 posti laterale fisso - bracciolo DX o SX 2 lateral places fix - armrest DX o SX	141
	2 posti laterale letto - bracciolo DX o SX 2 lateral places bed - armrest DX o SX	212
	Poltrona laterale fisso - bracciolo DX o SX Armchair lateral fix - armrest DX o SX	81
	Chaiselongue laterale fissa/apribile bracciolo DX o SX Lateral fixed/storaged chaiselongue armrest DX o SX	106
	Chaiselongue laterale fissa/apribile bracciolo DX o SX Lateral fixed/storaged chaiselongue armrest DX o SX	106
	Pouff fisso/contenitore Fixed/storaged pouf	

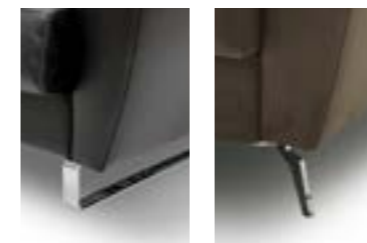

SLI

PNY

Disponibile con piedini /
available with feet /



Personalità
per spazi
confortevoli.
Exceptional character,
exceptional comfort.



94
ODINO /



Quando il dinamismo
diventa design.
When dynamism turns into design.

95
ODINO /





Divano letto con rete elettrosaldata e cinghie elastiche, materasso H 13 cm.
 Completamente sfoderabile con rivestimento in tessuto. Composto da elementi smontabili per facilitare il trasporto e la sfoderabilità.
 Montaggio degli elementi con sistema a baionetta. Struttura: agglomerato di legno foderato con tessuto vellutino termoaccoppiato ad un sottile strato di poliuretano espanso. Imbottitura: schienali e sedute in poliuretano espanso indeformabile avvolte con falda siliconata.

Sofa bed with electrowelded bed case, elastic belts and mattress H 13 cm.
 Fully removable covers for fabric upholstery.
 Composed by disassembled pieces for an easy transportation or cover removal.
 Assembly of pieces by metal sliding-rail brackets. Structure: wooden agglomerate lined with fine velvet fabric thermocoupled to a thin layer of polyurethane foam.
 Filling: back and seat cushions in indeformable polyurethane foam, silicone coated.

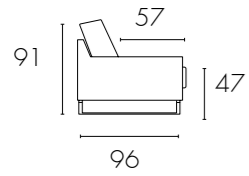

Dimensione con braccioli tipo / Size with armrests type

A

	3 posti max fisso 3,5 places fix		3 posti max letto 3,5 places bed Materasso cm 160 x 197 Mattress cm 160 x 197	230
	3 posti fisso 3 places fix		3 posti letto 3 places bed Materasso cm 140 x 197 Mattress cm 140 x 197	210
	Intermedio fisso 2,5 places fix		Intermedio letto 2,5 places bed Materasso cm 120 x 197 Mattress cm 120 x 197	190
	2 posti fisso 2 places fix		2 posti letto 2 places bed Materasso cm 100 x 197 Mattress cm 100 x 197	170
	Poltrona fisso Armchair fix		Poltrona letto Armchair bed Materasso cm 70 x 197 Mattress cm 70 x 197	140
	3 posti max laterale fisso - bracciolo DX o SX 3,5 lateral places - armrest DX o SX		3 posti max laterale letto - bracciolo DX o SX 3,5 lateral places bed - armrest DX o SX	207
	3 posti laterale fisso - bracciolo DX o SX 3 lateral places fix - armrest DX o SX		3 posti laterale letto - bracciolo DX o SX 3 lateral places bed - armrest DX o SX	187
	Intermedio laterale fisso - bracciolo DX o SX 2,5 lateral places fix - armrest right or left		Intermedio letto - bracciolo DX o SX 2,5 lateral places bed - armrest DX o SX	167



A
23 cm



Dimensione con braccioli tipo / Size with armrests type

A

	2 posti laterale fisso - bracciolo DX o SX 2 lateral places fix - armrest DX o SX		2 posti laterale letto - bracciolo DX o SX 2 lateral places bed - armrest DX o SX	147
	Poltrona laterale fisso - bracciolo DX o SX Armchair lateral fix - armrest DX o SX		Poltrona laterale letto - bracciolo DX o SX Armchair lateral bed - armrest DX o SX	117
	Chaiselongue laterale fissa/apribile bracciolo DX o SX Lateral fixed/storaged chaiselongue armrest DX o SX			106
	Chaiselongue laterale fissa/apribile bracciolo DX o SX Lateral fixed/storaged chaiselongue armrest DX o SX			106
	Pouff fisso/contenitore Fixed/storaged pouf			



Disponibile con piedini /
available with feet /

THOR



103
THOR /

Coniuga bellezza,
funzionalità e comfort.
The perfect coniugation of beauty,
functionality and comfort.



104
THOR /







108
THOR /

Dalla forte personalità anche nella
versione letto.
With a strong personality even
in the bed version.









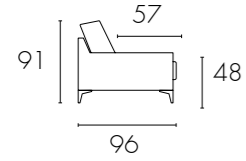

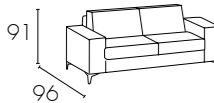
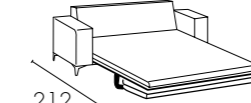

109
THOR /

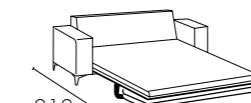
Divano letto con rete elettrosaldata e cinghie elastiche, materasso H 13 cm.
 Non sfoderabile. Composto da elementi smontabili per facilitare il trasporto.
 Montaggio degli elementi con sistema a baionetta. Struttura: agglomerato di legno
 foderato con tessuto vellutino termoaccoppiato ad un sottile strato di poliuretano
 espanso. Imbottitura: schienali e sedute in poliuretano
 espanso indeformabile avvolte con falda siliconata.

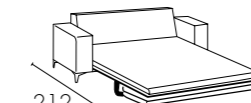
Sofa bed with electrowelded bed case, elastic belts and mattress H 13 cm.
 Fabric not removable. Composed by disassembled pieces for an easy transportation.
 Assembly of pieces by metal sliding-rail brackets. Structure: wooden agglomerate
 lined with fine velvet fabric thermocoupled to a thin layer of polyurethane foam.
 Filling: back and seat cushions in indeformable polyurethane foam, silicone coated.

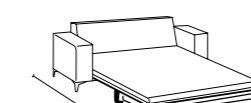

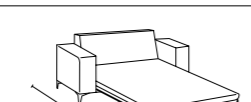

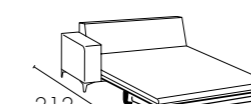
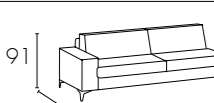
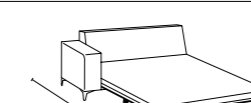
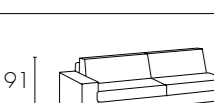
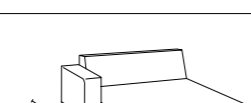

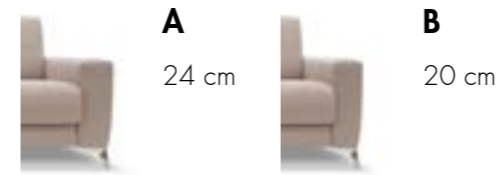



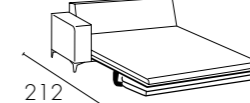

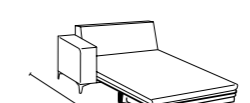
Dimensione con braccioli tipo / Size with armrests type

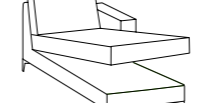
				A	B
	3 posti max fisso 3,5 places fix		3 posti max letto 3,5 places bed Materasso cm 160 x 197 Mattress cm 160 x 197	232	224
	3 posti fisso 3 places fix		3 posti letto 3 places bed Materasso cm 140 x 197 Mattress cm 140 x 197	212	204
	Intermedio fisso 2,5 places fix		Intermedio letto 2,5 places bed Materasso cm 120 x 197 Mattress cm 120 x 197	192	184
	2 posti fisso 2 places fix		2 posti letto 2 places bed Materasso cm 100 x 197 Mattress cm 100 x 197	172	164
	Poltrona letto Armchair bed Materasso cm 70 x 197 Mattress cm 70 x 197		Poltrona letto Armchair bed Materasso cm 70 x 197 Mattress cm 70 x 197	142	134
	Poltrona fissa Armchair fix			112	104
	3 posti max laterale fisso - bracciolo DX o SX 3,5 lateral places - armrest DX o SX		3 posti max laterale letto - bracciolo DX o SX 3,5 lateral places bed - armrest DX o SX	208	204
	3 posti laterale fisso - bracciolo DX o SX 3 lateral places fix - armrest DX o SX		3 posti laterale letto - bracciolo DX o SX 3 lateral places bed - armrest DX o SX	188	184
	Intermedio laterale fisso - bracciolo DX o SX 2,5 lateral places fix - armrest right or left		Intermedio letto - bracciolo DX o SX 2,5 lateral places bed - armrest DX o SX	168	164

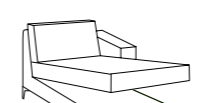
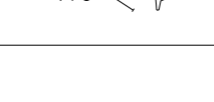

Dimensione con braccioli tipo / Size with armrests type

				A	B
	2 posti laterale fisso - bracciolo DX o SX 2 lateral places fix - armrest DX o SX		2 posti laterale letto - bracciolo DX o SX 2 lateral places bed - armrest DX o SX	148	144
	Poltrona laterale letto - bracciolo DX o SX Armchair lateral bed - armrest DX o SX		Poltrona laterale letto - bracciolo DX o SX Armchair lateral bed - armrest DX o SX	118	114
	Poltrona laterale fisso - bracciolo DX o SX Armchair lateral fix - armrest DX o SX			88	84
	Chaiselongue laterale fissa/apribile bracciolo DX o SX Lateral fixed/storaged chaiselongue armrest DX o SX			106	102
	Chaiselongue laterale fissa/apribile bracciolo DX o SX Lateral fixed/storaged chaiselongue armrest DX o SX			106	102
	Pouff fisso/contenitore Fixed/storaged pouf				
			Disponibile con piedini / available with feet /		



NIZZA

La precisione delle finiture artigianali
contribuisce a creare
un prodotto di assoluta qualità.
The precise craftsmanlike finishing
helps make soul
a product of the highest quality.



114
NIZZA /







Divano letto con rete elettrosaldata e cinghie elastiche, materasso H 13 cm (materasso H 18 cm con opzione). Composto da elementi smontabili per facilitare il trasporto. Montaggio degli elementi con sistema a baionetta. Struttura: agglomerato di legno foderato con tessuto vellutino termoaccoppiato ad un sottile strato di poliuretano espanso. Imbottitura: schienali e sedute in poliuretano espanso indeformabile avvolte con falda siliconata.

Sofa bed with electrowelded bed case, elastic belts and mattress H 13 cm (mattress H 18 cm with option). Composed by disassembled pieces for an easy transportation. Assembly of pieces by metal sliding-rail brackets. Structure: wooden agglomerate lined with fine velvet fabric thermocoupled to a thin layer of polyurethane foam. Filling: back and seat cushions in indeformable polyurethane foam, silicone coated.

**MATERASSO H 18 CM CON OPZIONE
MATTRESS H 18 CM WITH OPTION**

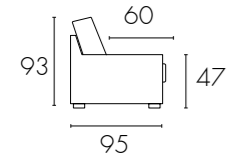

Dimensione con braccioli tipo / Size with armrests type

			A	B	C	
	3 posti max fisso 3,5 places fix		3 posti max letto 3,5 places bed Materasso cm 160 x 197 Mattress cm 160 x 197	224	218	212
	3 posti fisso 3 places fix		3 posti letto 3 places bed Materasso cm 140 x 197 Mattress cm 140 x 197	204	198	192
	3 posti max laterale fisso - bracciolo DX o SX 3,5 lateral places - armrest DX o SX		3 posti max laterale letto - bracciolo DX o SX 3,5 lateral places bed - armrest DX o SX	204	201	198
	3 posti laterale fisso - bracciolo DX o SX 3 lateral places fix - armrest DX o SX		3 posti laterale letto - bracciolo DX o SX 3 lateral places bed - armrest DX o SX	184	181	178



Dimensione con braccioli tipo / Size with armrests type

			A	B	C
	Chaiselongue laterale fissa/apribile bracciolo DX o SX Lateral fixed/storaged chaiselongue armrest DX o SX		106	103	100
	Chaiselongue laterale fissa/apribile bracciolo DX o SX Lateral fixed/storaged chaiselongue armrest DX o SX		106	103	100
	Pouff fisso/contenitore Fixed/storaged pouf				



Disponibile con piedini /
available with feet /



DUBAI

Unico nel suo genere,
unisce qualità e comfort.
Unique in his category,
combine quality and comfort.



124
DUBAI / 3P





126
DUBAI /



Il comfort è garantito dai generosi
braccioli e dai poggiatesta reclinabili.
The comfort is guaranteed by the
generous arms and the adjustable
headrest.

Monocromatico o bicolore
per renderlo unico e personale.
Monochrome or two-tone
to make it unique and personal.



128
DUBAI /
EXAMPLES OF COLORS

Nella variante bicolore,
Dubai perde la sua allure classica
mostrando una natura post moderna.
In the bicolour variants,
Dubai loses its classical allure,
showing a post-modern nature.

Divano letto con rete elettrosaldata e cinghie elastiche, materasso H 13 cm (materasso H 18 cm con opzione). Completamente sfoderabile con rivestimento in tessuto. Composto da elementi smontabili per facilitare il trasporto e la sfoderabilità. Montaggio degli elementi con sistema a baionetta. Struttura: agglomerato di legno foderato con tessuto vellutino termocoppiato ad un sottile strato di poliuretano espanso. Imbottitura: schienali e sedute in poliuretano espanso indeformabile avvolte con falda siliconata. Vano porta guanciali su retro schienale.

Sofa bed with electrowelded bed case, elastic belts and mattress H 13 cm (mattress H 18 cm with option). Fully removable covers for fabric upholstery. Composed by disassembled pieces for an easy transportation or cover removal. Assembly of pieces by metal sliding-rail brackets. Structure: wooden agglomerate lined with fine velvet fabric thermocoupled to a thin layer of polyurethane foam. Filling: back and seat cushions in indeformable polyurethane foam, silicone coated. Pillow compartment on sofa back.

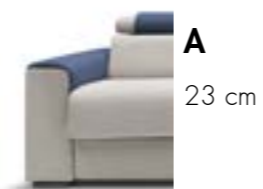

**MATERASSO H 18 CM CON OPZIONE
MATTRESS H 18 CM WITH OPTION**

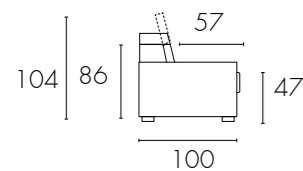

Dimensione con braccioli tipo / Size with armrests type

Dimensione con braccioli tipo / Size with armrests type		A
	3 posti max fisso 3,5 places fix	3 posti max letto 3,5 places bed Materasso cm 160 x 197 Mattress cm 160 x 197
	3 posti fisso 3 places fix	3 posti letto 3 places bed Materasso cm 140 x 197 Mattress cm 140 x 197
	Intermedio fisso 2,5 places fix	Intermedio letto 2,5 places bed Materasso cm 120 x 197 Mattress cm 120 x 197
	2 posti fisso 2 places fix	2 posti letto 2 places bed Materasso cm 100 x 197 Mattress cm 100 x 197
	3 posti max laterale fisso - bracciolo DX o SX 3,5 lateral places - armrest DX o SX	3 posti max laterale letto - bracciolo DX o SX 3,5 lateral places bed - armrest DX o SX
	3 posti laterale fisso - bracciolo DX o SX 3 lateral places fix - armrest DX o SX	3 posti laterale letto - bracciolo DX o SX 3 lateral places bed - armrest DX o SX
	Intermedio laterale fisso - bracciolo DX o SX 2,5 lateral places fix - armrest right or left	Intermedio letto - bracciolo DX o SX 2,5 lateral places bed - armrest DX o SX

Dimensione con braccioli tipo / Size with armrests type

Dimensione con braccioli tipo / Size with armrests type		A
	2 posti laterale fisso - bracciolo DX o SX 2 lateral places fix - armrest DX o SX	2 posti laterale letto - bracciolo DX o SX 2 lateral places bed - armrest DX o SX
	Chaiselongue laterale fissa/apribile bracciolo DX o SX Lateral fixed/storaged chaiselongue armrest DX o SX	
	Chaiselongue laterale fissa/apribile bracciolo DX o SX Lateral fixed/storaged chaiselongue armrest DX o SX	
	Pouff fisso/contenitore Fixed/storaged pouff	



Disponibile con piedini / available with feet /

REVERS



133
REVERS / B
+ CHAISERLONGUE TONDA

Revers è una famiglia di
imbottiti dove ogni elemento
identifica un percorso
fatto di ricerca.
Revers is a family of
upholstered furniture when
each element defines a
path of research.



134
REVERS / B
+ CHAISERLONGUE TONDA



135
REVERS / B



136
REVERS / H
+ DORMOUSE

Personalità
per spazi
confortevoli.
Exceptional character,
exceptional comfort.



138
REVERS /
G + CHAISERLONGUE /

Dalla forte personalità anche nella
versione letto.
With a strong personality even
in the bed version.





BRACCIOLO TIPO "A" 21 CM
ARMREST TYPE "A" 21 CM



BRACCIOLO TIPO "D" 7 CM
ARMREST TYPE "D" 7 CM



BRACCIOLO TIPO "B" 17 CM
ARMREST TYPE "B" 17 CM



BRACCIOLO TIPO "E" 3,5 CM
ARMREST TYPE "E" 3,5 CM



BRACCIOLO TIPO "C" 12 CM
ARMREST TYPE "C" 12 CM



BRACCIOLO TIPO "F" 3,5 CM
ARMREST TYPE "F" 3,5 CM





BRACCIOLO TIPO "G" 21 CM
ARMREST TYPE "G" 21 CM

BRACCIOLO TIPO "I" 21 CM
ARMREST TYPE "I" 21 CM



BRACCIOLO TIPO "H" 30 CM
ARMREST TYPE "H" 30 CM

BRACCIOLO TIPO "L" 22 CM
ARMREST TYPE "L" 22 CM

Divano letto con rete elettrosaldata e cinghie elastiche, materasso H 13 cm (materasso H 18 cm con opzione). Completamente sfoderabile con rivestimento in tessuto. Composto da elementi smontabili per facilitare il trasporto e la sfoderabilità. Montaggio degli elementi con sistema a baionetta. Struttura: agglomerato di legno foderato con tessuto vellutino termoaccoppiato ad un sottile strato di poliuretano espanso. Imbottitura: schienali e sedute in poliuretano espanso indeformabile avvolte con falda siliconata. Vano porta guanciali su retro schienale.

Sofa bed with electrowelded bed case, elastic belts and mattress H 13 cm (mattress H 18 cm with option). Fully removable covers for fabric upholstery. Composed by disassembled pieces for an easy transportation or cover removal. Assembly of pieces by metal sliding-rail brackets. Structure: wooden agglomerate lined with fine velvet fabric thermocoupled to a thin layer of polyurethane foam. Filling: back and seat cushions in indeformable polyurethane foam, silicone coated. Pillow compartment on sofa back.

**MATERASSO H 18 CM CON OPZIONE
MATTRESS H 18 CM WITH OPTION**

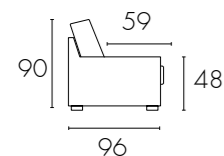

Dimensione con braccioli tipo / Size with armrests type

		A	B	C	D	E	F	G	H	I	L		
	3 posti max fisso 3,5 places fix		3 posti max letto 3,5 places bed Materasso cm 160 x 197 Mattress cm 160 x 197	224	216	206	196	189	189	224	242	224	226
	3 posti fisso 3 places fix		3 posti letto 3 places bed Materasso cm 140 x 197 Mattress cm 140 x 197	204	196	186	176	169	169	204	222	204	206
	Intermedio fisso 2,5 places fix		Intermedio letto 2,5 places bed Materasso cm 120 x 197 Mattress cm 120 x 197	184	176	166	156	149	149	184	202	184	186
	2 posti fisso 2 places fix		2 posti letto 2 places bed Materasso cm 100 x 197 Mattress cm 100 x 197	164	156	146	136	129	129	164	182	164	166
			Poltrona letto Armchair bed Materasso cm 70 x 197 Mattress cm 70 x 197	134	126	116	106	99	99	134	152	134	136
	Poltrona fissa Armchair fix			104	96	86	76	69	69	104	122	104	106
	3 posti max laterale fisso - bracciolo DX o SX 3,5 lateral places - armrest DX o SX		3 posti max laterale letto - bracciolo DX o SX 3,5 lateral places bed - armrest DX o SX	203	199	194	189	186	186	203	213	203	204
	3 posti laterale fisso - bracciolo DX o SX 3 lateral places fix - armrest DX o SX		3 posti laterale letto - bracciolo DX o SX 3 lateral places bed - armrest DX o SX	183	179	174	169	166	166	183	193	183	184
	Intermedio laterale fisso - bracciolo DX o SX 2,5 lateral places fix - armrest right or left		Intermedio letto - bracciolo DX o SX 2,5 lateral places bed - armrest DX o SX	163	159	154	149	146	146	163	173	163	164

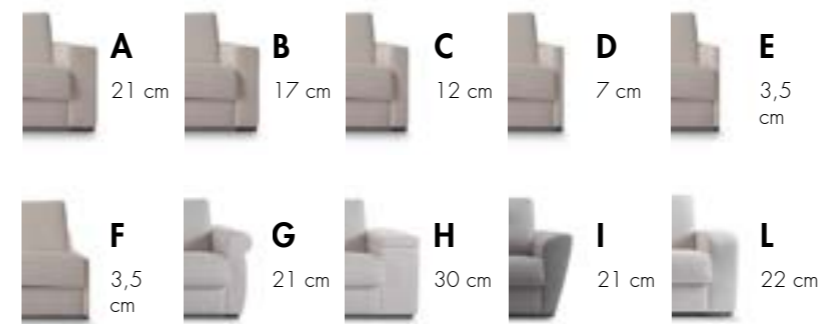

Dimensione con braccioli tipo / Size with armrests type

		A	B	C	D	E	F	G	H	I	L		
	2 posti laterale fisso - bracciolo DX o SX 2 lateral places fix - armrest DX o SX		2 posti laterale letto - bracciolo DX o SX 2 lateral places bed - armrest DX o SX	143	139	134	129	126	126	143	153	143	144
			Poltrona laterale letto - bracciolo DX o SX Armchair lateral bed - armrest DX o SX	113	109	104	99	96	96	113	123	113	114
	Poltrona laterale fisso - bracciolo DX o SX Armchair lateral fix - armrest DX o SX			83	79	74	69	66	66	83	93	83	84
	Chaiselongue laterale tonda fissa/apribile bracciolo DX o SX lateralCircleChaiselonguefixed/ openablearmrest dx o sx			103	99	94	89	86	86	103	112	103	104
	Chaiselongue laterale fissa/apribile bracciolo DX o SX Lateral fixed/stored chaiselongue armrest DX o SX			103	99	94	89	86	86	103	112	103	104
	Dormeuse laterale fissa bracciolo DX o SX Lateral fixed dormeuse armrest DX o SX			103									
	Pouff fisso/contenitore Fixed/stored pouff												



Disponibile con piedini /
available with feet /





Un carattere deciso capace di
esaltarsi attraverso il
perfezionamento dei particolari.
A strong character brought out in
carefully
selected details.



150
MABEL /





Divano letto con rete elettrosaldata e cinghie elastiche, materasso H 13 cm (materasso H 18 cm con opzione). Completamente sfoderabile con rivestimento in tessuto. Composto da elementi smontabili per facilitare il trasporto e la sfoderabilità. Montaggio degli elementi con sistema a baionetta. Struttura: agglomerato di legno foderato con tessuto vellutino termoaccoppiato ad un sottile strato di poliuretano espanso. Imbottitura: cuscini schienali in fiocco di fibra di poliestere 200g/m³ e sedute in poliuretano espanso indeformabile avvolte con falda siliconata.

Sofa bed with electrowelded bed case, elastic belts and mattress H 13 cm (mattress H 18 cm with option). Fully removable covers for fabric upholstery. Composed by disassembled pieces for an easy transportation or cover removal. Assembly of pieces by metal sliding-rail brackets. Structure: wooden agglomerate lined with fine velvet fabric thermocoupled to a thin layer of polyurethane foam. Filling: backrest cushions made of polyester fiber flakes 200 g/m³ and seat cushions in indeformable polyurethane foam, silicone coated.

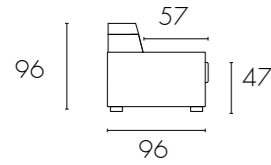

**MATERASSO H 18 CM CON OPZIONE
MATTRESS H 18 CM WITH OPTION**

Dimensione con braccioli tipo / Size with armrests type

				A
	3 posti max fisso 3,5 places fix		3 posti max letto 3,5 places bed Materasso cm 160 x 197 Mattress cm 160 x 197	225
	3 posti fisso 3 places fix		3 posti letto 3 places bed Materasso cm 140 x 197 Mattress cm 140 x 197	205
	Intermedio fisso 2,5 places fix		Intermedio letto 2,5 places bed Materasso cm 120 x 197 Mattress cm 120 x 197	185
	2 posti fisso 2 places fix		2 posti letto 2 places bed Materasso cm 100 x 197 Mattress cm 100 x 197	165
	Poltrona letto Armchair bed		Poltrona letto Armchair bed Materasso cm 70 x 197 Mattress cm 70 x 197	135
	Poltrona fisso Armchair fix			105
	3 posti max laterale fisso - bracciolo DX o SX 3,5 lateral places - armrest DX o SX		3 posti max laterale letto - bracciolo DX o SX 3,5 lateral places bed - armrest DX o SX	204
	3 posti laterale fisso - bracciolo DX o SX 3 lateral places fix - armrest DX o SX		3 posti laterale letto - bracciolo DX o SX 3 lateral places bed - armrest DX o SX	184
	Intermedio laterale fisso - bracciolo DX o SX 2,5 lateral places fix - armrest right or left		Intermedio letto - bracciolo DX o SX 2,5 lateral places bed - armrest DX o SX	164



A
21 cm



Dimensione con braccioli tipo / Size with armrests type

				A
	2 posti laterale fisso - bracciolo DX o SX 2 lateral places fix - armrest DX o SX		2 posti laterale letto - bracciolo DX o SX 2 lateral places bed - armrest DX o SX	144
	Poltrona laterale fisso - bracciolo DX o SX Armchair lateral fix - armrest DX o SX		Poltrona laterale letto - bracciolo DX o SX Armchair lateral bed - armrest DX o SX	114
	Poltrona laterale fisso - bracciolo DX o SX Armchair lateral fix - armrest DX o SX			84
			Chaiselongue laterale fissa/apribile bracciolo DX o SX Lateral fixed/storaged chaiselongue armrest DX o SX	103
			Chaiselongue laterale fissa/apribile bracciolo DX o SX Lateral fixed/storaged chaiselongue armrest DX o SX	103
			Pouff fisso/contenitore Fixed/storaged pouf	



Disponibile con piedini /
available with feet /

ELOISE



Eloise è una famiglia di imbottiti dove lo spazio prende una nuova forma, con il morbido schienale e i poggiatesta reclinabili.
Eloise is a family of upholstered furniture when the space has a new shape with the soft backrest and reclining headrest.



158
ELOISE /





Divano letto con rete elettrosaldata e cinghie elastiche, materasso H 13 cm (materasso H 18 cm con opzione). Completamente sfoderabile con rivestimento in tessuto. Composto da elementi smontabili per facilitare il trasporto e la sfoderabilità. Montaggio degli elementi con sistema a baionetta. Struttura: agglomerato di legno foderato con tessuto vellutino termoaccoppiato ad un sottile strato di poliuretano espanso. Imbottitura: schienali e sedute in poliuretano espanso indeformabile avvolte con falda siliconata. Vano porta guanciali su retro schienale.



Sofa bed with electrowelded bed case, elastic belts and mattress H 13 cm (mattress H 18 cm with option). Fully removable covers for fabric upholstery. Composed by disassembled pieces for an easy transportation or cover removal. Assembly of pieces by metal sliding-rail brackets. Structure: wooden agglomerate lined with fine velvet fabric thermocoupled to a thin layer of polyurethane foam. Filling: back and seat cushions in indeformable polyurethane foam, silicone coated. Pillow compartment on sofa back.



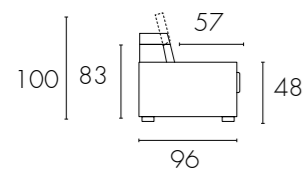

**MATERASSO H 18 CM CON OPZIONE
MATTRESS H 18 CM WITH OPTION**

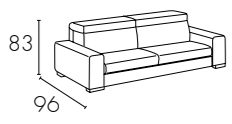
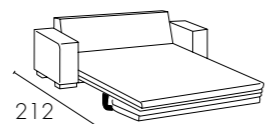
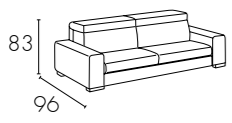
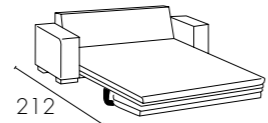
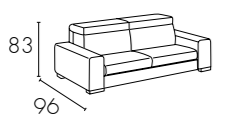
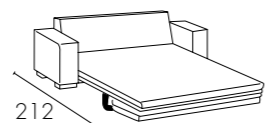
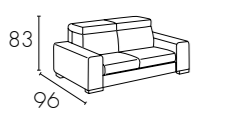
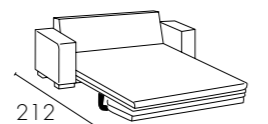

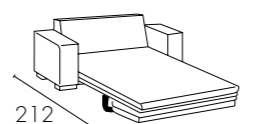
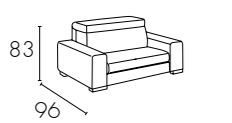
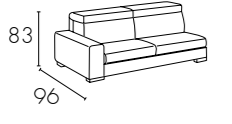
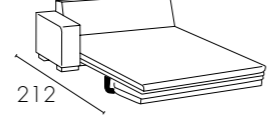
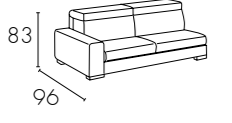
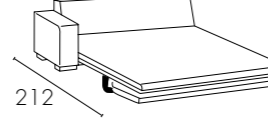
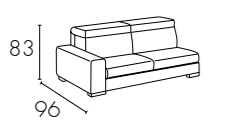
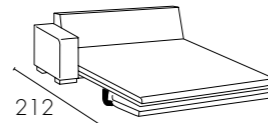
Dimensione con braccioli tipo / Size with armrests type

				A	B	C
	3 posti max fisso 3,5 places fix		3 posti max letto 3,5 places bed Materasso cm 160 x 197 Mattress cm 160 x 197	229	221	211
	3 posti fisso 3 places fix		3 posti letto 3 places bed Materasso cm 140 x 197 Mattress cm 140 x 197	209	201	191
	Intermedio fisso 2,5 places fix		Intermedio letto 2,5 places bed Materasso cm 120 x 197 Mattress cm 120 x 197	189	181	171
	2 posti fisso 2 places fix		2 posti letto 2 places bed Materasso cm 100 x 197 Mattress cm 100 x 197	169	161	151
	Poltrona letto Armchair bed Materasso cm 70 x 197 Mattress cm 70 x 197		Poltrona letto Armchair bed Materasso cm 70 x 197 Mattress cm 70 x 197	139	131	121
	Poltrona fissa Armchair fix			109	101	91
	3 posti max laterale fisso - bracciolo DX o SX 3,5 lateral places - armrest DX o SX		3 posti max laterale letto - bracciolo DX o SX 3,5 lateral places bed - armrest DX o SX	206	202	197
	3 posti laterale fisso - bracciolo DX o SX 3 lateral places fix - armrest DX o SX		3 posti laterale letto - bracciolo DX o SX 3 lateral places bed - armrest DX o SX	186	182	177
	Intermedio laterale fisso - bracciolo DX o SX 2,5 lateral places fix - armrest right or left		Intermedio letto - bracciolo DX o SX 2,5 lateral places bed - armrest DX o SX	166	162	157

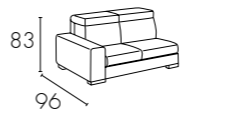
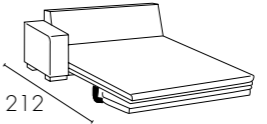
Dimensione con braccioli tipo / Size with armrests type

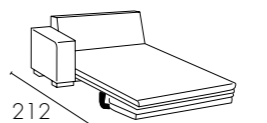
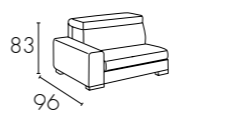
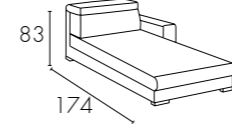
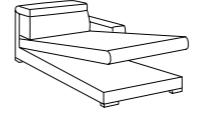
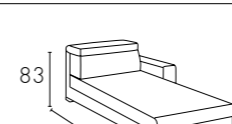
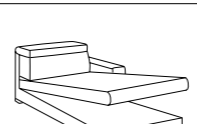
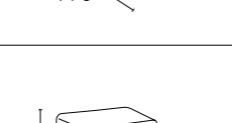
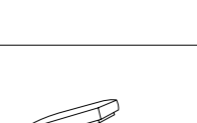
				A	B	C
	2 posti laterale fisso - bracciolo DX o SX 2 lateral places fix - armrest DX o SX		2 posti laterale letto - bracciolo DX o SX 2 lateral places bed - armrest DX o SX	146	142	137
	Poltrona laterale fisso - bracciolo DX o SX Armchair lateral fix - armrest DX o SX		Poltrona laterale letto - bracciolo DX o SX Armchair lateral bed - armrest DX o SX	116	112	107
	Poltrona laterale fisso - bracciolo DX o SX Armchair lateral fix - armrest DX o SX			86	82	77
	Chaiselongue laterale fissa/apribile bracciolo DX o SX Lateral fixed/storaged chaiselongue armrest DX o SX			109	105	100
	Chaiselongue laterale fissa/apribile bracciolo DX o SX Lateral fixed/storaged chaiselongue armrest DX o SX			109	105	100
	Pouff fisso/contenitore Fixed/storaged pouf					



Disponibile con piedini /
available with feet /

STILOS



Dal design ricercato, le comode sedute ed i poggiatesta reclinabili assicurano grande comfort.
Sophisticated design, the comfortable seating/seat and reclining headrest ensure great comfort.



166
STILOSIO /





168
STILOSO /



170
STILOS0 /
3P + 3P MAX

171
STILOS0 /
3P + 3P MAX

Divano letto con rete elettrosaldata e cinghie elastiche, materasso H 13 cm.
 Completamente sfoderabile con rivestimento in tessuto. Composto da elementi smontabili per facilitare il trasporto e la sfoderabilità.
 Montaggio degli elementi con sistema a baionetta. Struttura: agglomerato di legno foderato con tessuto vellutino termoaccoppiato ad un sottile strato di poliuretano espanso. Imbottitura: schienali e sedute in poliuretano espanso indeformabile avvolte con falda siliconata.
 Vano porta guanciali su retro schienale.

Sofa bed with electrowelded bed case, elastic belts and mattress H 13 cm.
 Fully removable covers for fabric upholstery.
 Composed by disassembled pieces for an easy transportation or cover removal.
 Assembly of pieces by metal sliding-rail brackets. Structure: wooden agglomerate lined with fine velvet fabric thermocoupled to a thin layer of polyurethane foam.
 Filling: back and seat cushions in indeformable polyurethane foam, silicone coated.
 Pillow compartment on sofa back.

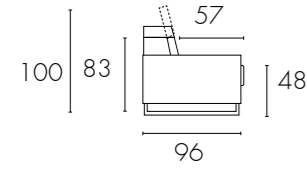

Dimensione con braccioli tipo / Size with armrests type

			A	B	C	
	3 posti max fisso 3,5 places fix		3 posti max letto 3,5 places bed Materasso cm 160 x 197 Mattress cm 160 x 197	229	221	211
	3 posti fisso 3 places fix		3 posti letto 3 places bed Materasso cm 140 x 197 Mattress cm 140 x 197	209	201	191
	Intermedio fisso 2,5 places fix		Intermedio letto 2,5 places bed Materasso cm 120 x 197 Mattress cm 120 x 197	189	181	171
	2 posti fisso 2 places fix		2 posti letto 2 places bed Materasso cm 100 x 197 Mattress cm 100 x 197	169	161	151
	Poltrona fisso Armchair fix		Poltrona letto Armchair bed Materasso cm 70 x 197 Mattress cm 70 x 197	139	131	121
	3 posti max laterale fisso - bracciolo DX o SX 3,5 lateral places fix - armrest DX o SX		3 posti max laterale letto - bracciolo DX o SX 3,5 lateral places bed - armrest DX o SX	206	202	197
	3 posti laterale fisso - bracciolo DX o SX 3 lateral places fix - armrest DX o SX		3 posti laterale letto - bracciolo DX o SX 3 lateral places bed - armrest DX o SX	186	182	177
	Intermedio laterale fisso - bracciolo DX o SX 2,5 lateral places fix - armrest right or left		Intermedio letto - bracciolo DX o SX 2,5 lateral places bed - armrest DX o SX	166	162	157



Dimensione con braccioli tipo / Size with armrests type

			A	B	C	
	2 posti laterale fisso - bracciolo DX o SX 2 lateral places fix - armrest DX o SX		2 posti laterale letto - bracciolo DX o SX 2 lateral places bed - armrest DX o SX	146	142	137
	Poltrona laterale fisso - bracciolo DX o SX Armchair lateral fix - armrest DX o SX		Poltrona laterale letto - bracciolo DX o SX Armchair lateral bed - armrest DX o SX	116	112	107
	Poltrona laterale fisso - bracciolo DX o SX Armchair lateral fix - armrest DX o SX			86	82	77
	Chaiselongue laterale fissa/apribile bracciolo DX o SX Lateral fixed/storaged chaiselongue armrest DX o SX			109	105	100
	Chaiselongue laterale fissa/apribile bracciolo DX o SX Lateral fixed/storaged chaiselongue armrest DX o SX			109	105	100
	Pouff fisso/contenitore Fixed/storaged pouf					

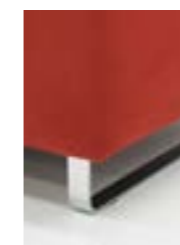

Disponibile con piedini /
available with feet /

LOIS



Importante
nella presenza e cura dei dettagli.
Important
in the presence and
attentive to the details.



176
LOIS /





Divano letto con rete elettrosaldata e cinghie elastiche, materasso H 13 cm (materasso H 18 cm con opzione). Non sfoderabile. Composto da elementi smontabili per facilitare il trasporto. Montaggio degli elementi con sistema a baionetta. Struttura: agglomerato di legno foderato con tessuto vellutino termoaccoppiato ad un sottile strato di poliuretano espanso. Imbottitura: cuscini schienali in fiocco di fibra di poliestere 200g/m3 e sedute in poliuretano espanso indeformabile avvolte con falda siliconata.

Sofa bed with electrowelded bed case, elastic belts and mattress H 13 cm (mattress H 18 cm with option). Fabric not removable. Composed by disassembled pieces for an easy transportation. Assembly of pieces by metal sliding-rail brackets. Structure: wooden agglomerate lined with fine velvet fabric thermocoupled to a thin layer of polyurethane foam. Filling: backrest cushions made of polyester fiber flakes 200 g/m3 and seat cushions in indeformable polyurethane foam, silicone coated.

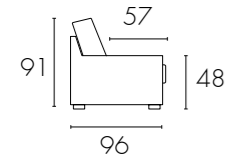



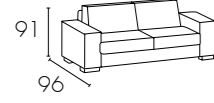
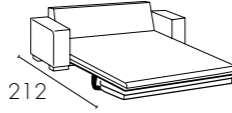
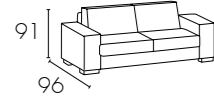
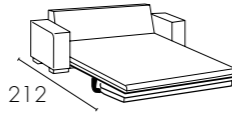
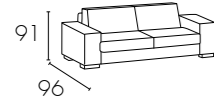
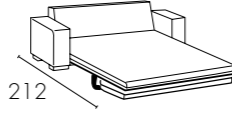
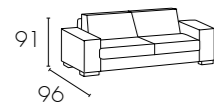
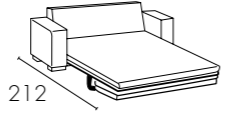
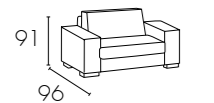
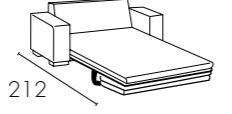
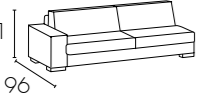
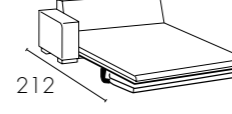
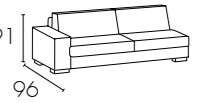
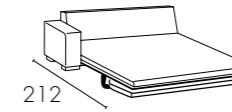
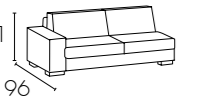
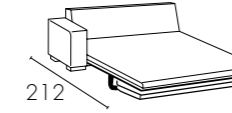

**MATERASSO H 18 CM CON OPZIONE
MATTRESS H 18 CM WITH OPTION**

Dimensione con braccioli tipo / Size with armrests type

			A	B	C	D	E
	3 posti max fisso 3,5 places fix		232	224	214	204	225
	3 posti fisso 3 places fix		212	204	194	184	205
	Intermedio fisso 2,5 places fix		192	184	174	164	185
	2 posti fisso 2 places fix		172	164	154	144	165
	Poltrona fissa Armchair fix		142	134	124	114	135
	3 posti max laterale fisso - bracciolo DX o SX 3,5 lateral places - armrest DX o SX		208	204	199	194	205
	3 posti laterale fisso - bracciolo DX o SX 3 lateral places fix - armrest DX o SX		188	184	179	174	185
	Intermedio laterale fisso - bracciolo DX o SX 2,5 lateral places fix - armrest right or left		168	164	159	154	165

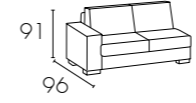
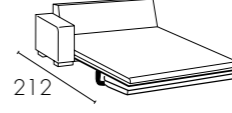
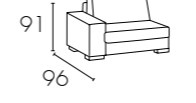
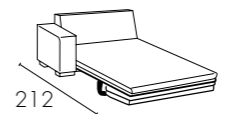
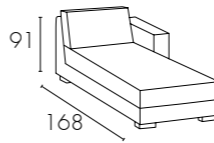
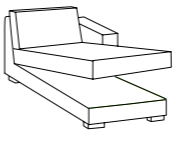
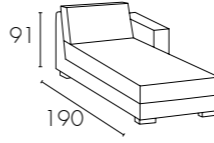
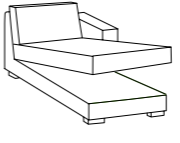
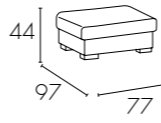
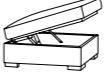

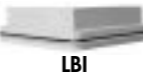
Dimensione con braccioli tipo / Size with armrests type

			A	B	C	D	E	
	2 posti laterale fisso - bracciolo DX o SX 2 lateral places fix - armrest DX o SX		148	144	139	134	145	
	Poltrona laterale fisso - bracciolo DX o SX Armchair lateral fix - armrest DX o SX		118	114	109	104	115	
	Chaiselongue laterale fissa/apribile bracciolo DX o SX Lateral fixed/storaged chaiselongue armrest DX o SX		106	102	97	92	103	
	Chaiselongue laterale fissa/apribile bracciolo DX o SX Lateral fixed/storaged chaiselongue armrest DX o SX		106	102	97	92	103	
	Pouff fisso/contenitore Fixed/storaged pouff							
	LWE		LCI		LBI		LAL	Disponibile con piedini / available with feet /

SLIDE



Dalla linea slanciata e
inconfondibile.
Slender and unmistakable line.



184
SLIDE /







Divano letto con rete elettrosaldata e cinghie elastiche, materasso H 13 cm.
 Completamente sfoderabile e rivestimento in tessuto. Composto da elementi smontabili per facilitare il trasporto e la sfoderabilità.
 Montaggio degli elementi con sistema a baionetta. Struttura: agglomerato di legno foderato con tessuto vellutino termocoppiato ad un sottile strato di poliuretano espanso. Imbottitura: schienali e sedute in poliuretano espanso indeformabile avvolte con falda siliconata.

Sofa bed with electrowelded bed case, elastic belts and mattress H 13 cm.
 Fully removable covers for fabric upholstery.
 Composed by disassembled pieces for an easy transportation or cover removal.
 Assembly of pieces by metal sliding-rail brackets. Structure: wooden agglomerate lined with fine velvet fabric thermocoupled to a thin layer of polyurethane foam.
 Filling: back and seat cushions in indeformable polyurethane foam, silicone coated.

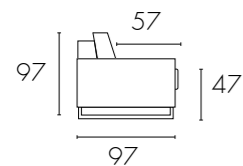
SLIDE



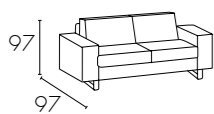
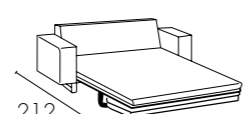
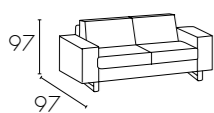
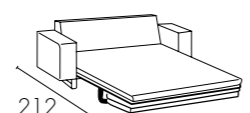
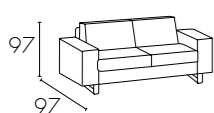
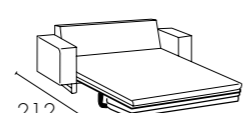
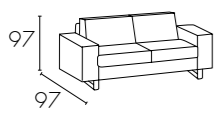
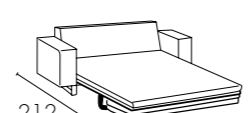

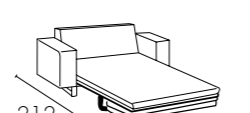
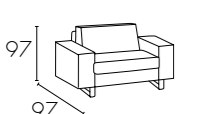
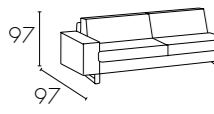
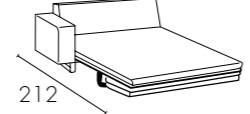
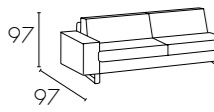
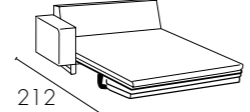
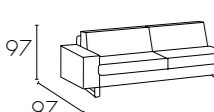
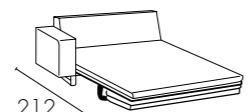

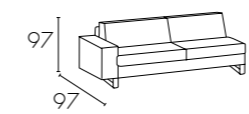
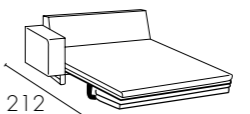

Dimensione con braccioli tipo / Size with armrests type

			A	B	C
	3 posti max fisso 3,5 places fix				
			233	225	215
	3 posti fisso 3 places fix				
			213	205	195
	Intermedio fisso 2,5 places fix				
			193	185	175
	2 posti fisso 2 places fix				
			173	165	155
	Poltrona letto Armchair bed				
			143	135	125
	Poltrona fissa Armchair fix				
			113	105	95
	3 posti max laterale fisso - bracciolo DX o SX 3,5 lateral places - armrest DX o SX				
			209	205	200
	3 posti laterale fisso - bracciolo DX o SX 3 lateral places fix - armrest DX o SX				
			189	185	180
	Intermedio laterale fisso - bracciolo DX o SX 2,5 lateral places fix - armrest right or left				
			169	165	160

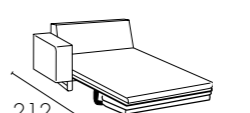
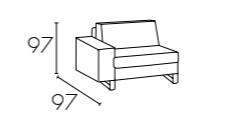
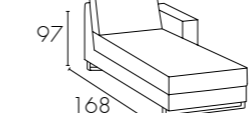
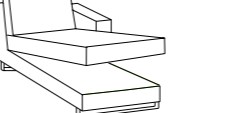
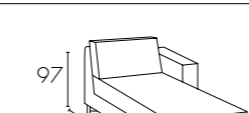
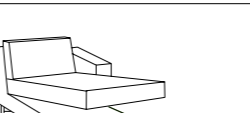

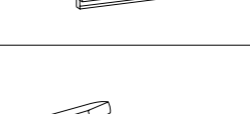
Dimensione con braccioli tipo / Size with armrests type

			A	B	C
	2 posti laterale fisso - bracciolo DX o SX 2 lateral places fix - armrest DX o SX				
			149	145	140
	Poltrona laterale letto - bracciolo DX o SX Armchair lateral bed - armrest DX o SX				
			119	115	110
	Poltrona laterale fisso - bracciolo DX o SX Armchair lateral fix - armrest DX o SX				
			89	85	80
	Chaiselongue laterale fissa/apribile bracciolo DX o SX Lateral fixed/storaged chaiselongue armrest DX o SX				
			106	102	97
	Chaiselongue laterale fissa/apribile bracciolo DX o SX Lateral fixed/storaged chaiselongue armrest DX o SX				
			106	102	97
	Pouff fisso/contenitore Fixed/storaged pouf				
	Disponibile con piedini / available with feet /				





La sua linea moderna
è arricchita da una bordatura
che disegna ed esalta
i profili morbidi del divano.
Its modern style is enhanced
by a border wich designs and
exalts the sofa soft profiles.



194
DAKAR /

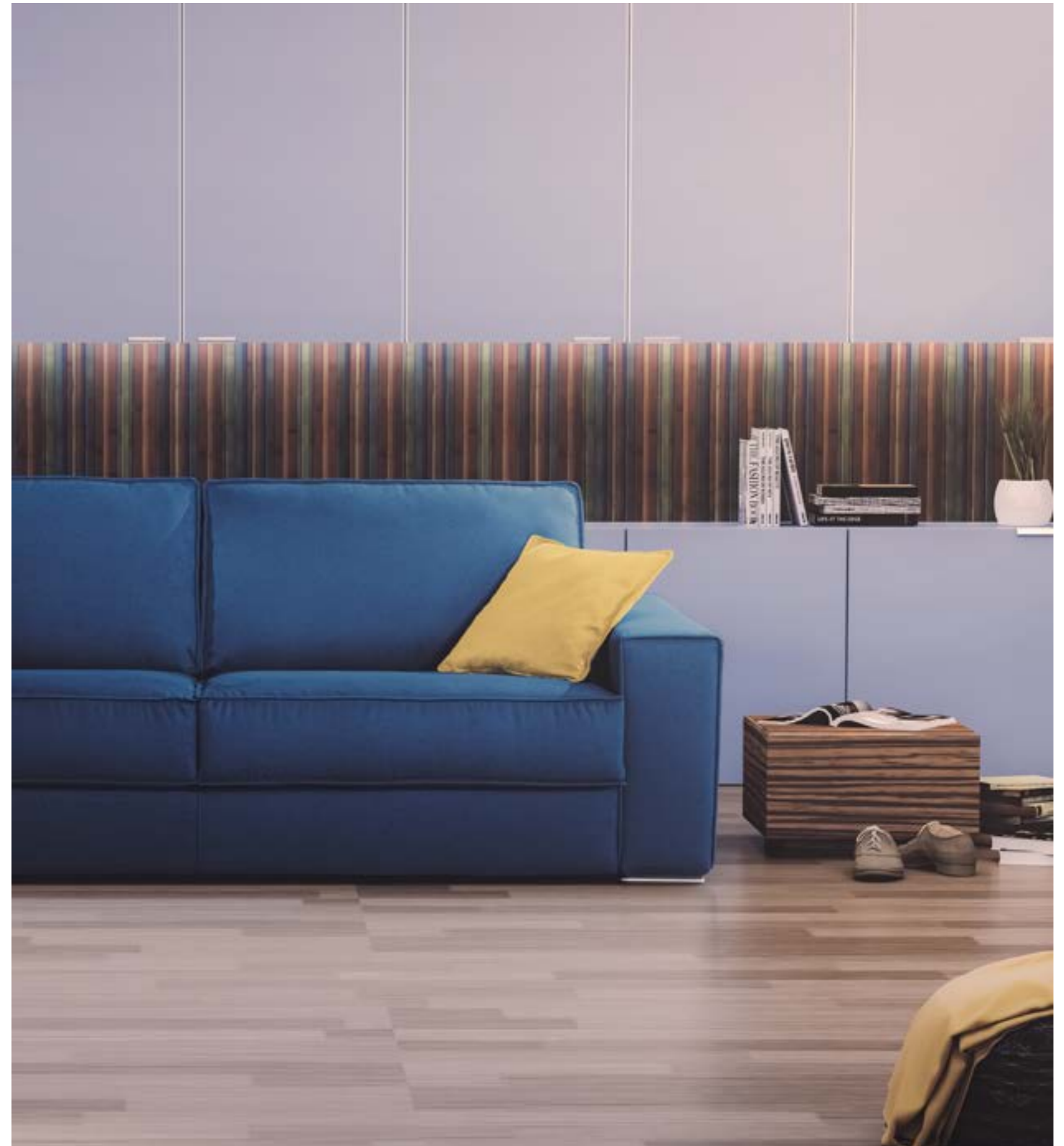









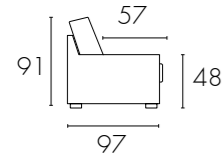

Divano letto con rete elettrosaldata e cinghie elastiche, materasso H 13 cm (materasso H 18 cm con opzione). Completamente sfoderabile con rivestimento in tessuto. Composto da elementi smontabili per facilitare il trasporto e la sfoderabilità. Montaggio degli elementi con sistema a baionetta. Struttura: agglomerato di legno foderato con tessuto vellutino termocoppiato ad un sottile strato di poliuretano espanso. Imbottitura: cuscini schienali in fiocco di fibra di poliestere 200g/m³ e sedute in poliuretano espanso indeformabile avvolte con falda siliconata.

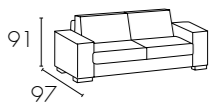
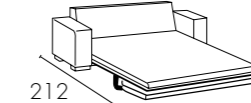
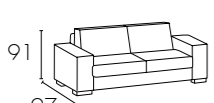
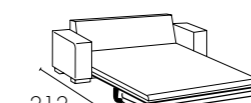
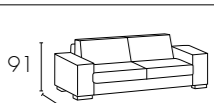
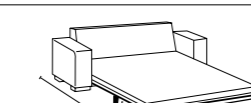
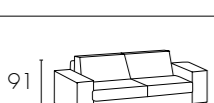
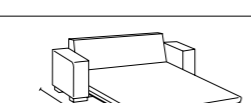
Sofa bed with electrowelded bed case, elastic belts and mattress H 13 cm (mattress H 18 cm with option). Fully removable covers for fabric upholstery. Composed by disassembled pieces for an easy transportation or cover removal. Assembly of pieces by metal sliding-rail brackets. Structure: wooden agglomerate lined with fine velvet fabric thermocoupled to a thin layer of polyurethane foam. Filling: backrest cushions made of polyester fiber flakes 200 g/m³ and seat cushions in indeformable polyurethane foam, silicone coated.

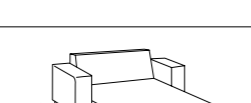
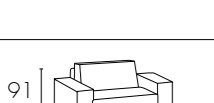
**MATERASSO H 18 CM CON OPZIONE
MATTRESS H 18 CM WITH OPTION**

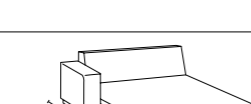

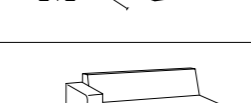



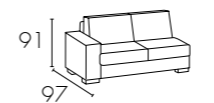
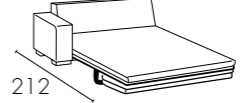

Dimensione con braccioli tipo / Size with armrests type

		A	B	C	D		
	3 posti max fisso 3,5 places fix		3 posti max letto 3,5 places bed Materasso cm 160 x 197 Mattress cm 160 x 197	229	221	211	201
	3 posti fisso 3 places fix		3 posti letto 3 places bed Materasso cm 140 x 197 Mattress cm 140 x 197	209	201	191	181
	Intermedio fisso 2,5 places fix		Intermedio letto 2,5 places bed Materasso cm 120 x 197 Mattress cm 120 x 197	189	181	171	161
	2 posti fisso 2 places fix		2 posti letto 2 places bed Materasso cm 100 x 197 Mattress cm 100 x 197	169	161	151	141
	Poltrona letto Armchair fix		Poltrona letto Armchair bed Materasso cm 70 x 197 Mattress cm 70 x 197	139	131	121	111
	Poltrona fissa Armchair fix			109	101	91	81
	3 posti max laterale fisso - bracciolo DX o SX 3,5 lateral places - armrest DX o SX		3 posti max laterale letto - bracciolo DX o SX 3,5 lateral places bed - armrest DX o SX	207	203	198	193
	3 posti laterale fisso - bracciolo DX o SX 3 lateral places fix - armrest DX o SX		3 posti laterale letto - bracciolo DX o SX 3 lateral places bed - armrest DX o SX	187	183	178	173
	Intermedio laterale fisso - bracciolo DX o SX 2,5 lateral places fix - armrest right or left		Intermedio laterale letto - bracciolo DX o SX 2,5 lateral places bed - armrest DX o SX	167	163	158	153

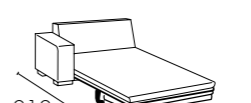
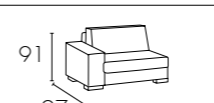
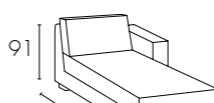
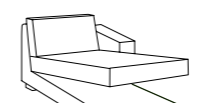
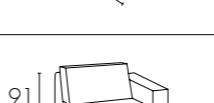

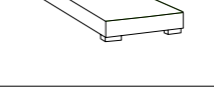
Dimensione con braccioli tipo / Size with armrests type

		A	B	C	D		
	2 posti laterale fisso - bracciolo DX o SX 2 lateral places fix - armrest DX o SX		2 posti laterale letto - bracciolo DX o SX 2 lateral places bed - armrest DX o SX	147	143	138	133
	Poltrona laterale letto - bracciolo DX o SX Armchair lateral bed - armrest DX o SX		Poltrona laterale letto - bracciolo DX o SX Armchair lateral bed - armrest DX o SX	117	113	108	103
	Poltrona laterale fisso - bracciolo DX o SX Armchair lateral fix - armrest DX o SX			87	83	78	73
	Chaiselongue laterale fissa/apribile bracciolo DX o SX Lateral fixed/storaged chaiselongue armrest DX o SX		Chaiselongue laterale fissa/apribile bracciolo DX o SX Lateral fixed/storaged chaiselongue armrest DX o SX	104	100	95	90
	Chaiselongue laterale fissa/apribile bracciolo DX o SX Lateral fixed/storaged chaiselongue armrest DX o SX		Chaiselongue laterale fissa/apribile bracciolo DX o SX Lateral fixed/storaged chaiselongue armrest DX o SX	104	100	95	90
	Pouff fisso/contenitore Fixed/storaged pouf		Pouff fisso/contenitore Fixed/storaged pouf				
	LWE LCI LBI LAL						

Disponibile con piedini /
available with feet /



Arricchisce di stile sia le
ambientazioni
classiche che quelle moderne.
It enriched
modern and classic environments.



202
STEP /





Divano letto con rete elettrosaldata e cinghie elastiche, materasso H 13 cm.
 Completamente sfoderabile con rivestimento in tessuto. Composto da elementi smontabili per facilitare il trasporto e la sfoderabilità.
 Montaggio degli elementi con sistema a baionetta. Struttura: agglomerato di legno foderato con tessuto vellutino termoaccoppiato ad un sottile strato di poliuretano espanso. Imbottitura: schienali e sedute in poliuretano espanso indeformabile avvolte con falda siliconata.
 Vano porta guanciali su retro schienale.

Sofa bed with electrowelded bed case, elastic belts and mattress H 13 cm.
 Fully removable covers for fabric upholstery.
 Composed by disassembled pieces for an easy transportation or cover removal.
 Assembly of pieces by metal sliding-rail brackets. Structure: wooden agglomerate lined with fine velvet fabric thermocoupled to a thin layer of polyurethane foam.
 Filling: back and seat cushions in indeformable polyurethane foam, silicone coated.
 Pillow compartment on sofa back.

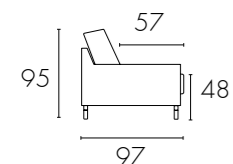

Dimensione con braccioli tipo / Size with armrests type

			A	B
	3 posti max fisso 3,5 places fix		231	223
	3 posti fisso 3 places fix		211	203
	Intermedio fisso 2,5 places fix		191	183
	2 posti fisso 2 places fix		171	163
	Poltrona letto Armchair bed		141	133
	Poltrona fissa Armchair fix		111	103
	3 posti max laterale fisso - bracciolo DX o SX 3,5 lateral places - armrest DX o SX		208	204
	3 posti laterale fisso - bracciolo DX o SX 3 lateral places fix - armrest DX o SX		188	184
	Intermedio laterale fisso - bracciolo DX o SX 2,5 lateral places fix - armrest right or left		168	164



Dimensione con braccioli tipo / Size with armrests type

			A	B
	2 posti laterale fisso - bracciolo DX o SX 2 lateral places fix - armrest DX o SX		148	144
	Poltrona laterale letto - bracciolo DX o SX Armchair lateral bed - armrest DX o SX		118	114
	Poltrona laterale fisso - bracciolo DX o SX Armchair lateral fix - armrest DX o SX		88	84
	Chaiselongue laterale fissa/apribile bracciolo DX o SX Lateral fixed/storaged chaiselongue armrest DX o SX		105	101
	Chaiselongue laterale fissa/apribile bracciolo DX o SX Lateral fixed/storaged chaiselongue armrest DX o SX		105	101
	Pouff fisso/contenitore Fixed/storaged pouff			



PST SLI LGN

Disponibile con piedini /
available with feet /



Le ampie sedute e i soffici
schienali
assicurano il massimo comfort.
The large seats and the soft
backrest
ensure the best comfort.



210
ROCKY /





Viene esaltata la pregiata
manifattura italiana.
It is exalted by the fine Italian
manufacture.









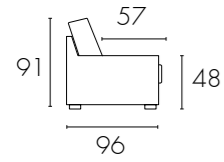

213
ROCKY /

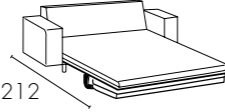
Divano letto con rete elettrosaldata e cinghie elastiche, materasso H 13 cm.
 Completamente sfoderabile (ad eccezione dei cuscini schienali) con rivestimento in tessuto. Composto da elementi smontabili per facilitare il trasporto e la sfoderabilità. Montaggio degli elementi con sistema a baionetta. Struttura: agglomerato di legno foderato con tessuto vellutino termoaccoppiato ad un sottile strato di poliuretano espanso. Imbottitura: cuscini schienali in fiocco di fibra di poliestere 200g/m³ e sedute in poliuretano espanso indeformabile avvolte con falda siliconata.

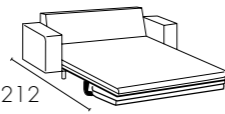
Sofa bed with electrowelded bed case, elastic belts and mattress H 13 cm.
 Fully removable covers (with the exception of the backrest cushions) for fabric upholstery. Composed by disassembled pieces for an easy transportation or cover removal. Assembly of pieces by metal sliding-rail brackets. Structure: wooden agglomerate lined with fine velvet fabric thermocoupled to a thin layer of polyurethane foam. Filling: backrest cushions made of polyester fiber flakes 200 g/m³ and seat cushions in indeformable polyurethane foam, silicone coated.

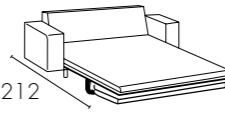

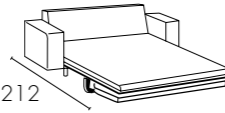
Dimensione con braccioli tipo / Size with armrests type

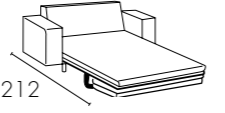
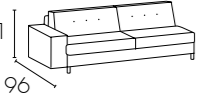
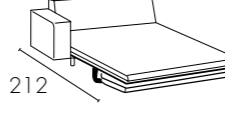
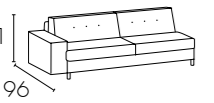
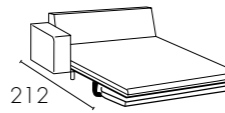
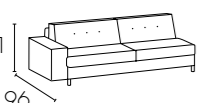
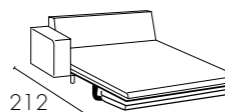

				A
	3 posti max fisso 3,5 places fix		3 posti max letto 3,5 places bed Materasso cm 160 x 197 Mattress cm 160 x 197	214
	3 posti fisso 3 places fix		3 posti letto 3 places bed Materasso cm 140 x 197 Mattress cm 140 x 197	194
	Intermedio fisso 2,5 places fix		Intermedio letto 2,5 places bed Materasso cm 120 x 197 Mattress cm 120 x 197	174
	2 posti fisso 2 places fix		2 posti letto 2 places bed Materasso cm 100 x 197 Mattress cm 100 x 197	154
	Poltrona fissa Armchair fix		Poltrona letto Armchair bed Materasso cm 70 x 197 Mattress cm 70 x 197	124
	3 posti max laterale fisso - bracciolo DX o SX 3,5 lateral places - armrest DX o SX		3 posti max laterale letto - bracciolo DX o SX 3,5 lateral places bed - armrest DX o SX	199
	3 posti laterale fisso - bracciolo DX o SX 3 lateral places fix - armrest DX o SX		3 posti laterale letto - bracciolo DX o SX 3 lateral places bed - armrest DX o SX	179
	Intermedio laterale fisso - bracciolo DX o SX 2,5 lateral places fix - armrest right or left		Intermedio letto - bracciolo DX o SX 2,5 lateral places bed - armrest DX o SX	159



A
15 cm

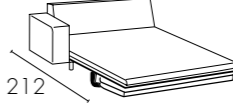
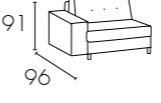
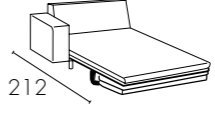
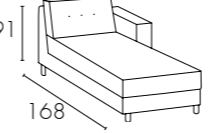
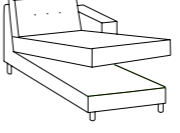
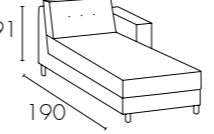
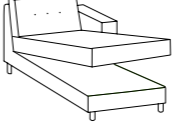
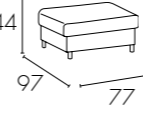

Dimensione con braccioli tipo / Size with armrests type

				A
	2 posti laterale fisso - bracciolo DX o SX 2 lateral places fix - armrest DX o SX		2 posti laterale letto - bracciolo DX o SX 2 lateral places bed - armrest DX o SX	139
	Poltrona laterale fisso - bracciolo DX o SX Armchair lateral fix - armrest DX o SX		Poltrona laterale letto - bracciolo DX o SX Armchair lateral bed - armrest DX o SX	109
	Chaiselongue laterale fissa/apribile bracciolo DX o SX Lateral fixed/storaged chaiselongue armrest DX o SX			97
	Chaiselongue laterale fissa/apribile bracciolo DX o SX Lateral fixed/storaged chaiselongue armrest DX o SX			97
	Pouff fisso/contenitore Fixed/storaged pouf			



Disponibile con piedini /
available with feet /

SHINE



Dal design moderno ed essenziale,
coniuga bellezza e funzionalità.
Essential and modern design, it
combines
beauty and functionality.



218
SHINE /





Divano letto con rete elettrosaldata e cinghie elastiche, materasso H 13 cm (materasso H 18 cm con opzione). Completamente sfoderabile con rivestimento in tessuto. Composto da elementi smontabili per facilitare il trasporto e la sfoderabilità. Montaggio degli elementi con sistema a baionetta. Struttura: agglomerato di legno foderato con tessuto vellutino termocoppiato ad un sottile strato di poliuretano espanso. Imbottitura: schienali e sedute in poliuretano espanso indeformabile avvolte con falda siliconata.

Sofa bed with electrowelded bed case, elastic belts and mattress H 13 cm (mattress H 18 cm with option). Fully removable covers for fabric upholstery. Composed by disassembled pieces for an easy transportation or cover removal. Assembly of pieces by metal sliding-rail brackets. Structure: wooden agglomerate lined with fine velvet fabric thermocoupled to a thin layer of polyurethane foam. Filling: back and seat cushions in indeformable polyurethane foam, silicone coated.

**MATERASSO H 18 CM CON OPZIONE
MATTRESS H 18 CM WITH OPTION**

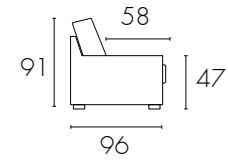

Dimensione con braccioli tipo / Size with armrests type

				A
	3 posti max fisso 3,5 places fix		3 posti max letto 3,5 places bed Materasso cm 160 x 197 Mattress cm 160 x 197	230
	3 posti fisso 3 places fix		3 posti letto 3 places bed Materasso cm 140 x 197 Mattress cm 140 x 197	210
	Intermedio fisso 2,5 places fix		Intermedio letto 2,5 places bed Materasso cm 120 x 197 Mattress cm 120 x 197	190
	2 posti fisso 2 places fix		2 posti letto 2 places bed Materasso cm 100 x 197 Mattress cm 100 x 197	170
	Poltrona fisso Armchair fix		Poltrona letto Armchair bed Materasso cm 70 x 197 Mattress cm 70 x 197	140
	3 posti max laterale fisso - bracciolo DX o SX 3,5 lateral places - armrest DX o SX		3 posti max laterale letto - bracciolo DX o SX 3,5 lateral places bed - armrest DX o SX	207
	3 posti laterale fisso - bracciolo DX o SX 3 lateral places fix - armrest DX o SX		3 posti laterale letto - bracciolo DX o SX 3 lateral places bed - armrest DX o SX	187
	Intermedio laterale fisso - bracciolo DX o SX 2,5 lateral places fix - armrest right or left		Intermedio letto - bracciolo DX o SX 2,5 lateral places bed - armrest DX o SX	167



Dimensione con braccioli tipo / Size with armrests type

				A
	2 posti laterale fisso - bracciolo DX o SX 2 lateral places fix - armrest DX o SX		2 posti laterale letto - bracciolo DX o SX 2 lateral places bed - armrest DX o SX	147
	Poltrona laterale fisso - bracciolo DX o SX Armchair lateral fix - armrest DX o SX		Poltrona laterale letto - bracciolo DX o SX Armchair lateral bed - armrest DX o SX	117
	Chaiselongue laterale fissa/apribile bracciolo DX o SX Lateral fixed/storaged chaiselongue armrest DX o SX			106
	Chaiselongue laterale fissa/apribile bracciolo DX o SX Lateral fixed/storaged chaiselongue armrest DX o SX			106
	Pouff fisso/contenitore Fixed/storaged pouff			



Disponibile con piedini /
available with feet /

MIRA



225
MIRA /



Linea pulita per
un divano efficiente
e funzionale.
Clean line for an efficient
and functional sofa.



226
MIRA /



DIVANO CON DOPIO LETTO con rete elettrosaldada e cinghie elastiche, materasso H 13 cm.
 Completamente sfoderabile con rivestimento in tessuto. Composto da elementi smontabili per facilitare il trasporto e la sfoderabilità.
 Struttura: agglomerato di legno foderato con tessuto vellutino termoaccoppiato ad un sottile strato di poliuretano espanso. Imbottitura: schienali e sedute in poliuretano espanso indeformabile avvolte con falda siliconata.

SOFA WITH DOUBLE BED with electrowelded bed case, elastic belts and mattress H 13 cm.
 Fully removable covers for fabric upholstery.
 Composed by disassembled pieces for an easy transportation or cover removal.
 Structure: wooden agglomerate lined with fine velvet fabric thermocoupled to a thin layer of polyurethane foam.
 Filling: back and seat cushions in indeformable polyurethane foam, silicone coated.

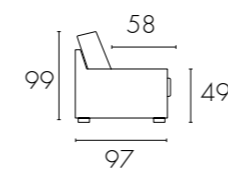

Dimensione con braccioli tipo / Size with armrests type

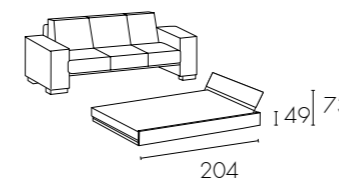
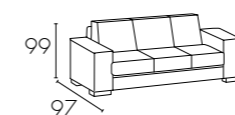

3 posti max letto
 3,5 places bed
 Materasso cm 80 x 190 x 12
 Mattress cm 80 x 190 x 12

A	B
225	204



A
14 cm



B
3,5 cm



LWE



LCI



LBI



LAL

Disponibile con piedini solo per bracciolo tipo A / Available with feet only for type A armrest /

MARLEN



La perfetta sinergia tra lo stile
classico e le linee moderne.
The perfect synergy between
classical and modern lines.



232
MARLEN /





234
MARLEN /

Divano letto con rete elettrosaldata e cinghie elastiche, materasso H 13 cm (materasso H 18 cm con opzione). Completamente sfoderabile con rivestimento in tessuto. Composto da elementi smontabili per facilitare il trasporto e la sfoderabilità. Montaggio degli elementi con sistema a baionetta. Struttura: agglomerato di legno foderato con tessuto vellutino termocoppato ad un sottile strato di poliuretano espanso. Imbottitura: cuscini schienali in fiocco di fibra di poliestere 200g/m³ e sedute in poliuretano espanso indeformabile avvolte con falda siliconata.

Sofa bed with electrowelded bed case, elastic belts and mattress H 13 cm (mattress H 18 cm with option). Fully removable covers for fabric upholstery. Composed by disassembled pieces for an easy transportation or cover removal. Assembly of pieces by metal sliding-rail brackets. Structure: wooden agglomerate lined with fine velvet fabric thermocoupled to a thin layer of polyurethane foam. Filling: backrest cushions made of polyester fiber flakes 200 g/m³ and seat cushions in indeformable polyurethane foam, silicone coated.

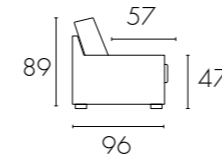

**MATERASSO H 18 CM CON OPZIONE
MATTRESS H 18 CM WITH OPTION**

Dimensione con braccioli tipo / Size with armrests type

				A
	3 posti max fisso 3,5 places fix		3 posti max letto 3,5 places bed Materasso cm 160 x 197 Mattress cm 160 x 197	244
	3 posti fisso 3 places fix		3 posti letto 3 places bed Materasso cm 140 x 197 Mattress cm 140 x 197	224
	Intermedio fisso 2,5 places fix		Intermedio letto 2,5 places bed Materasso cm 120 x 197 Mattress cm 120 x 197	204
			Pouff fisso/contenitore Fixed/storaged pouf	



Disponibile con piedini /
available with feet /

CHANTAL





La sua linea moderna
è arricchita da una bordatura
che disegna ed esalta
i profili morbidi del divano.
Its modern style is enhanced
by a border wich designs and
exalts the sofa soft profiles.



240
CHANTAL /



DIVANO CON DOPPIO LETTO A CASTELLO con rete elettrosaldata e cinghie elastiche, materasso H 13 cm.
 Completamente sfoderabile con rivestimento in tessuto. Composto da elementi smontabili per facilitare il trasporto e la sfoderabilità. Montaggio degli elementi con sistema a baionetta. Struttura: agglomerato di legno foderato con tessuto vellutino termoaccoppiato ad un sottile strato di poliuretano espanso. Imbottitura: schienali e sedute in poliuretano espanso indeformabile avvolte con falda siliconata.

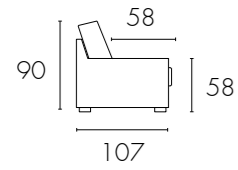

Dimensione con braccioli tipo / Size with armrests type

A

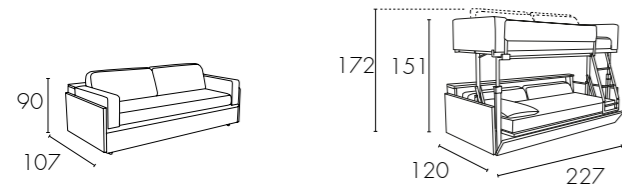

2 posti letto
 2 places bed

Materasso cm 80 x 190
 Mattress cm 80 x 190

227





244
TAIPEI /

TAIPEI

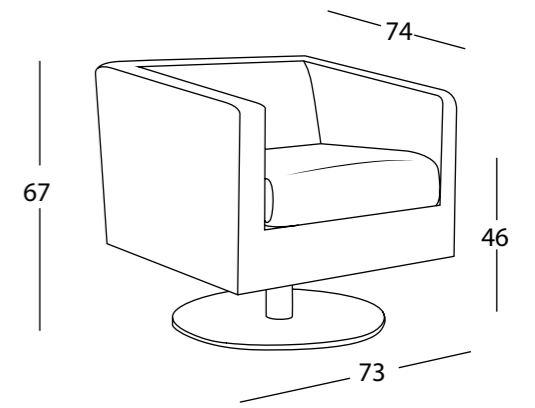

Grazie al suo design dalle linee minimali e rettangolari è adatta sia agli ambienti domestici che professionali.
Thanks to its design with minimal and rectangular lines, it is perfect both in domestic and professional environments.



LAGOS

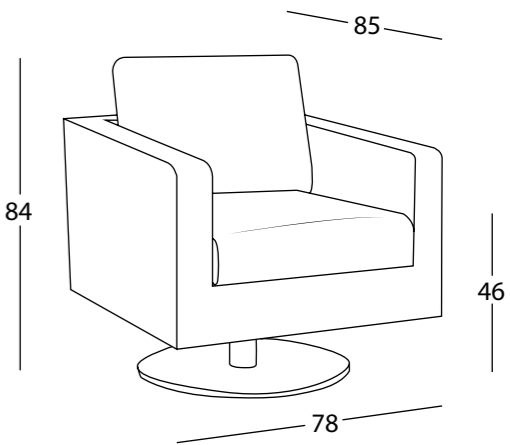

Variante della poltrona Taipei, con un morbido e più alto schienale.
Variant of Taipei armchair, with a soft and higher backrest.





248
ATENE /

ATENE

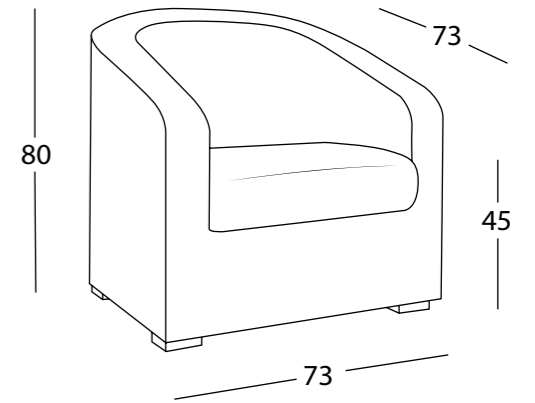

Disponibile con piedini /
available with feet /



La sua forma piacevole ed
avvolgente le dona stile e
comodità.
Its pleasant and enveloping shape gives
it style and comfort.





MUNICH

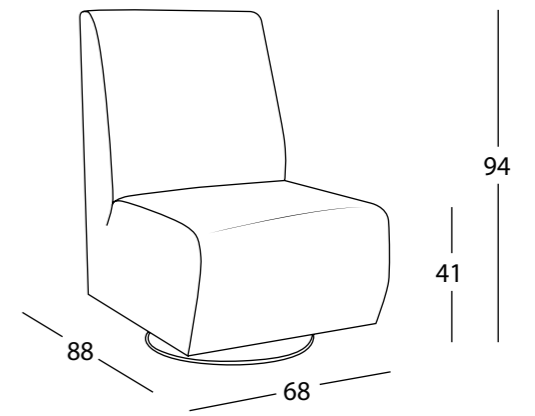

Linee morbide e soffici per la poltrona Munich, con base girevole in metallo.
Modern and soft lines for the armchair Munich, based on a swivel metal base.



PRETTY

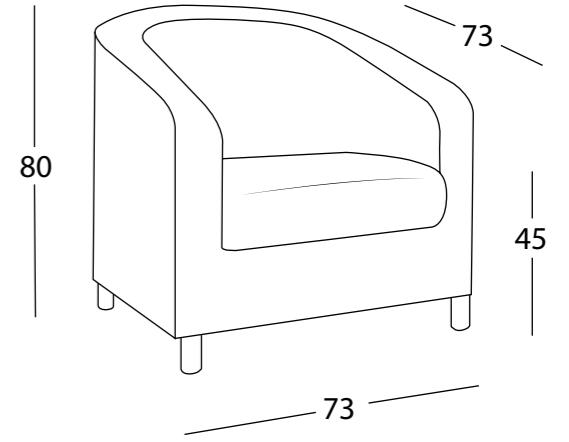

Pretty mescola classico e contemporaneo in una linea essenziale, ideale sia per il contract sia per la casa.

Pretty mixes classic and contemporary features in a basic line, perfect for contract projects and domestic solutions.



SANTIAGO

Il comfort è garantito dalla
forma rassicurante e
dall'estrema morbidezza
dell'imbottitura.

The reassuring shape and the extreme
softness of the padding guarantee the
Santiago chair comfort.



254
SANTIAGO /

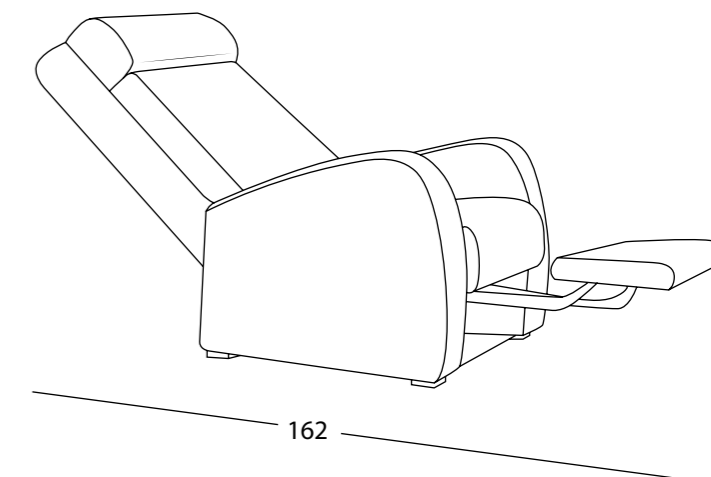
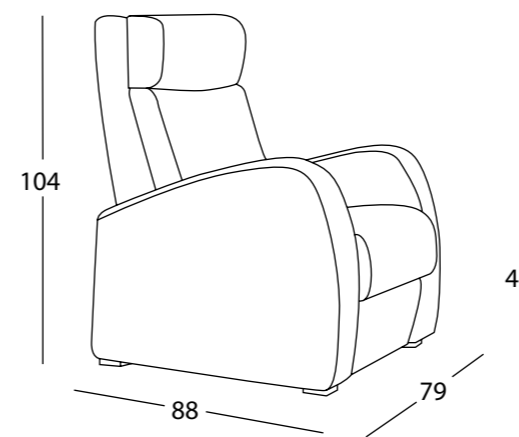

Esempi di alcuni modelli
Alterego nella versione
poltrone / poltrone-letto



ZEUS /
POLTRONA

Examples of some Alterego
models in the armchair /
armchair-bed version



REVERS / B
POLTRONA



ODINO /
POLTRONA



THOR /
POLTRONA



MATERASSI
MECCANISMI
REVERSIBILITÀ
CARATTERISTICHE
TESSUTI

MATTRESS
MECHANISMS
REVERSIBLE
FEATURES
FABRICS

Comfort Bultex®

Materasso H 14 / Mattress H 14 / Matelas H 14

CLASSIQUE

Un comfort morbido e progressivo grazie alla tecnica comfort BULTEX della schiuma di lattice microcellulare. Questa tecnica garantisce un supporto del corpo perfettamente bilanciato e un'eccellente ventilazione del materasso.

CLASSIQUE

Soft and progressive comfort thanks to the BULTEX comfort technique of the microcellular latex foam. This technique guarantees a perfectly balanced body support and excellent ventilation of the mattress.

CLASSIQUE

Un confort souple et progressif grâce à la technique du confort BULTEX de mousse latex micro alvéolé. Cette technique vous garantit un maintien parfaitement équilibré du corps ainsi qu'une excellente ventilation du matelas.



MATERASSO CON OPZIONE
MATTRESS OPTION
MATELAS AVEC OPTION

DENSITÀ 38 KG / M3
DENSITY 38 KG / M3

IPOALLERGENICO
HYPOALLERGENIC

TRATTAMENTI ANTI-ACARO
E ANTIBATTERICO
ANTI-MITE TREATMENTS
AND ANTIBACTERIAL

STRETCH 100% POLIESTERE
100% POLYESTER STRETCH

SPESSORE 14 CM
THICKNESS 14 CM

LUNGHEZZA 195 CM
LENGTH 195 CM

MORBIDO COMFORT
SOFT COMFORT

feel the
Sensation.

Materasso H 16 / Mattress H 16 / Matelas H 16

OPTIMUM

Un comfort morbido e progressivo grazie alla tecnica comfort BULTEX della schiuma di lattice microcellulare. Questa tecnica garantisce un supporto del corpo perfettamente bilanciato e un'eccellente ventilazione del materasso.

OPTIMUM

Soft and progressive comfort thanks to the BULTEX comfort technique of the microcellular latex foam. This technique guarantees a perfectly balanced body support and excellent ventilation of the mattress.

OPTIMUM

Un confort souple et progressif grâce à la technique du confort BULTEX de mousse latex micro alvéolé. Cette technique vous garantit un maintien parfaitement équilibré du corps ainsi qu'une excellente ventilation du matelas.



MATERASSO CON OPZIONE
MATTRESS OPTION
MATELAS AVEC OPTION

DENSITÀ 45 KG / M3
DENSITY 45 KG / M3

IPOALLERGENICO
HYPOALLERGENIC

TRATTAMENTI ANTI-ACARO
E ANTIBATTERICO
ANTI-MITE TREATMENTS
AND ANTIBACTERIAL

STRETCH 100% POLIESTERE
100% POLYESTER STRETCH

SPESSORE 16 CM
THICKNESS 16 CM

LUNGHEZZA 195 CM
LENGTH 195 CM

MORBIDO COMFORT
SOFT COMFORT

Comfort Bultex® est une marque déposée par Recticel

comfort
BULTEX®
supports life

Materassi H 13 / Mattress H 13 / Matelas H 13

STANDARD D25

Materasso in poliuretano di media densità rivestito in tessuto di poly-cotone losangato solo da un lato.



STANDARD D25

Mattress in polyurethane with medium density, covered with Quilted poly-cotton fabric and with anti-dust mite treatment.

STANDARD D25

Matelas en polyuréthane à densité moyenne. Recouvert de tissu en poly-coton losangé d'un seul côté.

MATERASSO DI SERIE
STANDARD MATTRESS
MATELAS DE SÉRIE

ANALLERGICO E ANTIBATTERICO
ANTIBACTERIAL- ANTI MITE
ANALLERGIQUE

POLTEX D35

Con i suoi 13 cm H il materasso poltex ad alta densità si colloca nella fascia dei materassi da letto assicurandone massimo comfort. È consigliato per un uso quotidiano del divano trasformabile. Rivestito con tessuto stretch anti acaro e anallergico.



POLTEX D35

Our mattress model Poltex H 13 cm has a high density. It is a real bed mattress recommended for those who use the sofa bed daily. Covered with hypoallergenic and anti-dust mite stretch fabric.

POLTEX D35

Matelas Poltex 13 cm H à haute densité. Il est placé dans le bande de matelas de lit en assurant confort extreme. Il est recommandé pour une utilisation quotidienne du canapé-lit. Recouvert de tissu extensible anti-acarien et anallergique.

ANALLERGICO E ANTIBATTERICO
ANTIBACTERIAL- ANTI MITE
ANALLERGIQUE

ALTA DENSITÀ
HIGH DENSITY
HAUTE DENSITÉ

TESSUTO STRETCH
STRETCH FABRIC
EXTENSIBLE TISSU

MATERASSO CON OPZIONE
MATTRESS OPTION
MATELAS AVEC OPTION

Materassi H 13 / Mattress H 13 / Matelas H 13

TOPPER SFODERABILE D35

Materasso con supporto in poliuretano ad altissima resilienza e con **TOPPER TRAPUNTA-TO CON MEMORY FOAM**. Questo sistema rende il materasso comodo e di alta qualità. Rivestito con tessuto stretch antiacaro e anallergico.



MATERASSO CON OPZIONE
MATTRESS OPTION
MATELAS AVEC OPTION

TOPPER REMOVABLE D35

Mattress with high resilience and polyurethane **CORE WITH MEMORY FOAM QUILTED TOPPER**. This system makes very high the quality of this mattress. Mattress covered with hypoallergenic and dust mite stretch fabric.

TOPPER DÉHOUSSABLE D35

Matelas avec support en polyuréthane à haute résilience et avec **TOPPER MATELAS-SÉ EN MEMORY FOAM**. Ce système rend le matelas confortable et de haute qualité. Recouvert de tissu extensible anti-acarien et anallergique.

ANALLERGICO E ANTIBATTERICO
ANTIBACTERIAL- ANTI MITE
ANALLERGIQUE

MEMORY FOAM
CONFORT MEMORY
MOUSSE À MÉMOIRE DE FORME

ALTA DENSITÀ
HIGH DENSITY
HAUTE DENSITÉ

TESSUTO STRETCH
STRETCH FABRIC
EXTENSIBLE TISSU

LAVAGGIO A SECCO
DRY CLEANING
NOTTOYAGE À SEC



Materassi H 18 / Mattress H 18 / Matelas H 18

MEDICAL D28

Materasso in poliuretano di media densità rivestito in tessuto di poly-cotone losangato solo da un lato.



MEDICAL D28

Mattress in polyurethane with medium density, covered with quilted poly-cotton fabric and with anti-dust mite treatment.

MEDICAL D28

Matelas en polyuréthane à densité moyenne. Recouvert de tissu en poly-coton losangé d'un seul côté.

MATERASSO CON OPZIONE
MATTRESS OPTION
MATELAS AVEC OPTION

ANALLERGICO E ANTIBATTERICO
ANTIBACTERIAL- ANTI MITE
ANALLERGIQUE

COMFORT D30 STRETCH

Con i suoi 18 cm H il materasso poltex ad alta densità si colloca nella fascia dei materassi da letto assicurandone massimo comfort. È consigliato per un uso quotidiano del divano trasformabile. Rivestito con tessuto stretch anti acaro e anallergico.



COMFORT D30 STRETCH

Our mattress model Poltex H 18 cm has a high density. It is a real bed mattress recommended for those who use the sofa bed daily. Covered with hypoallergenic and anti-dust mite stretch fabric.

COMFORT D30 STRETCH

Matelas Poltex 18 cm H à haute densité. Il est placé dans le bande de matelas de lit en assurant confort extreme. Il est recommandé pour une utilisation quotidienne du canapé-lit. Recouvert de tissu extensible anti-acarien et anallergique.

ANALLERGICO E ANTIBATTERICO
ANTIBACTERIAL- ANTI MITE
ANALLERGIQUE

ALTA DENSITÀ
HIGH DENSITY
HAUTE DENSITÉ

TESSUTO STRETCH
STRETCH FABRIC
EXTENSIBLE TISSU

MATERASSO CON OPZIONE
MATTRESS OPTION
MATELAS AVEC OPTION

Materassi H 18 / Mattress H 18 / Matelas H 18

DREAM D40 STRETCH

Materasso in poliuretano ad altissima resilienza e con bassa percentuale di deformazione. Questo è garanzia di un ottimo comfort nel momento del riposo. Rivestito con tessuto stretch anti acaro e anallergico.



MATERASSO CON OPZIONE
MATTRESS OPTION
MATELAS AVEC OPTION

DREAM D40 STRETCH

Polyuretane foam mattress with a high resiliency, and a low percentage of deformation, this a guarantee for a very high comfort for your rest. Covered with hypoallergenic and dust mite.

DREAM D40 STRETCH

Matelas en polyuréthane à haute résilience et faible pourcentage de déformation. Cela garantit un confort optimal pendant le repos. Recouvert de tissu extensible anti-acarien et anallergique.

ANALLERGICO E ANTIBATTERICO
ANTIBACTERIAL- ANTI MITE
ANALLERGIQUE

ALTA DENSITÀ
HIGH DENSITY
HAUTE DENSITÉ

TESSUTO STRETCH
STRETCH FABRIC
EXTENSIBLE TISSU

Attenzione / Attention / Attention

Differenza di altezza dei divani letto con materasso H 13 a H 18

The height difference between the sofa-bed with a 18 cm mattress and sofa-bed with a 13 cm mattress

Différence de hauteur des canapés-lits à partir de matelas H cm 13 à matelas H cm 18

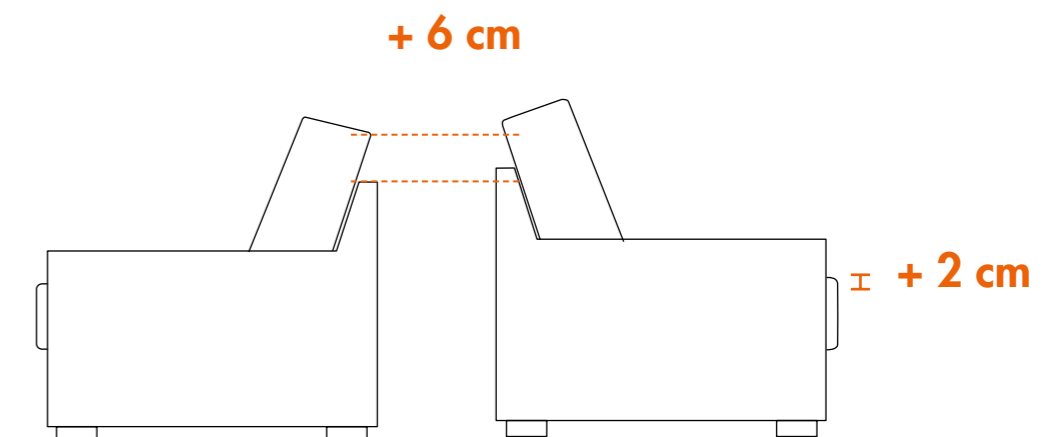

Meccanismi a ribalta / Mechanisms / Mécanismmes rabattables

FAST H13

Meccanismo a ribalta con sistema di apertura semplice. Telaio ad alta resistenza con verniciatura epossidica. Piano dormita con rete in acciaio elettrosaldato e cinghie elastiche.

FAST H13

Revolving mechanisms with easy opening system. High resistance frame with epoxy painting. Sleeping surface with base in fuse-bonded steel and elastic straps.

FAST H13

Mécanisme rabattable avec système d'ouverture simple. Cadre à haute résistance avec de la peinture époxy. Surface de couchage avec réseau en acier soudé et sangles élastiques.

MECCANICA DI SERIE
STANDART MECHANISM
MÉCANIQUE DE SÉRIE



HEIGHT COMFORT PRIVILEGE H18

Meccanismo a ribalta con sistema di apertura semplice. Telaio ad alta resistenza con verniciatura epossidica. Piano dormita con rete in acciaio elettrosaldato plastificata e cinghie elastiche.

HEIGHT COMFORT PRIVILEGE H18

Revolving mechanisms with easy opening system. High resistance frame with epoxy painting. Sleeping surface with base in fuse-bonded steel, plastified and elastic straps.

HEIGHT COMFORT PRIVILEGE H18

Mécanisme rabattable avec système d'ouverture simple. Cadre à haute résistance avec de la peinture époxy. Surface de couchage avec réseau en acier plastique soudé et sangles élastiques.

MECCANICA CON OPZIONE
MECHANISM OPTION
MÉCANIQUE AVEC OPTION



Meccanismi a ribalta / Mechanisms / Mécanismmes rabattables

DOGHE H13

Il meccanismo è fornito con innesti a baionetta che facilita il montaggio e smontaggio (braccioli, schienale, fascia) del divano, risolvendo il problema della movimentazione durante il trasporto.

DOGHE H13

The mechanic is supplied with bayonet fittings that makes easier the sofa's assembly (arms, back, sash), resolving the movement problem during the transport.

DOGHE H13

Le mécanisme est fourni avec des greffes à baïonnette qui facilitent le montage et démontage (accoudoirs, dossier, bandeau) du canapé, en résolvant ainsi le problème de manipulation durant le transport.

MECCANICA CON OPZIONE PER MATERASSI H13 E H14
MECHANISM OPTION FOR MATTRESS H13 AND H14
MÉCANIQUE AVEC OPTION POUR MATELAS H13 ET H14



Meccanismo da inserimento con sistema di apertura semplice ed unico, che consente di non rimuovere i cuscini della seduta e dello schienale del divano.

Insertion mechanism with unique and easy opening system, which consents to do not remove the sitting cushions and the back of the sofa.

Il meccanismo è fornito con doghe curve in faggio, che rendono il piano dormita ortopedico.

The mechanism is supplied with beech curved slats, which make the sleep surface orthopaedic.

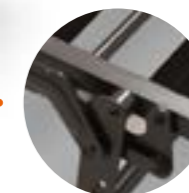
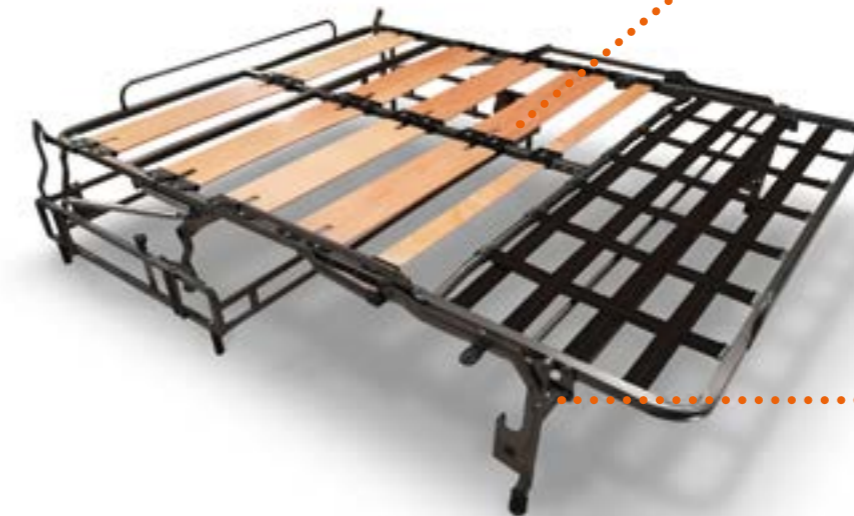

Telaio in tubo da mobilio ad alta resistenza con verniciatura epossidica.

Tubular frame for furniture with high resistance with epoxy painting.

Optional per meccanismi a ribalta

Mechanisms' optional / En option sur les mécanismes rabattables



LIFT UP

Innovativo sistema per tutti i meccanismi a ribalta, utile per il sollevamento del divano e per un facile spostamento.

LIFT UP

Innovative system for all evolving mechanisms, useful for the lifting of the sofa and easy movement.



LIFT UP

Système innovant pour tous les mécanismes rabattables, utile pour le soulèvement du canapé et pour faciliter le mouvement/déplacement.

Completamente smontabile

Completely dismantled / Complètement démontable

Completamente smontabile per facilitare il trasporto e la sfoderabilità. Montaggio degli elementi con sistema a baionetta.

The sofa can be easily dismantled for transportation or for cover removal. Assembling of the pieces by metal sliding-rail brackets.

Complètement démontable - Éléments séparables pour faciliter le transport ou pour dehousser complètement le canapé. Système à glissières pour le montage des accoudoirs et du dossier.

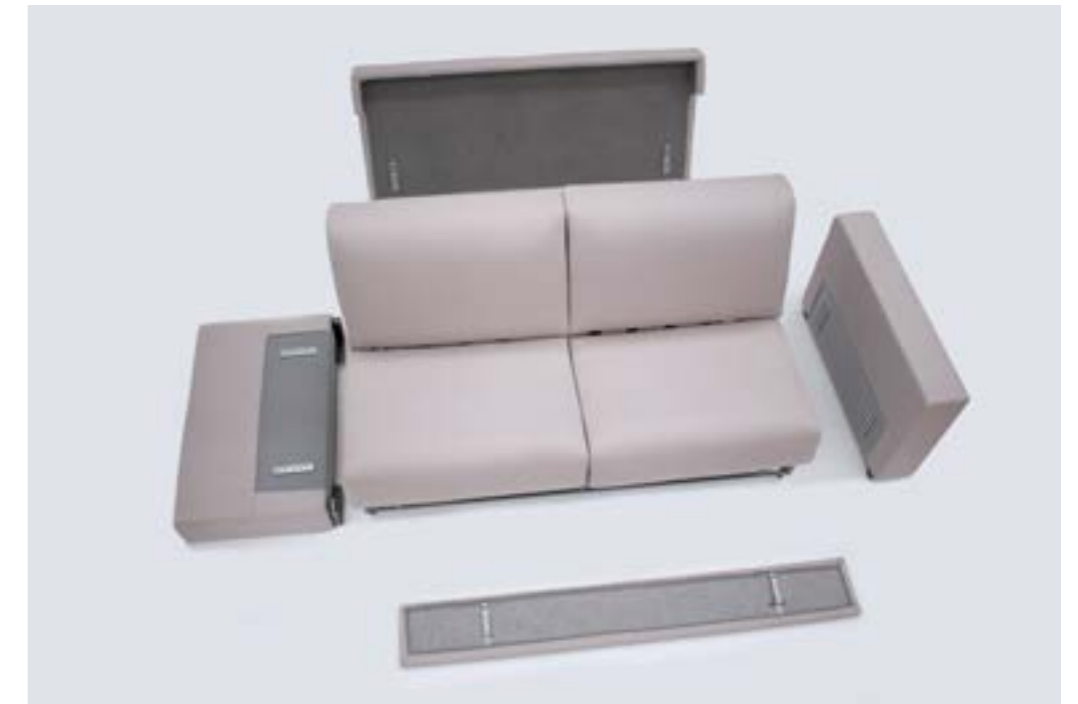

Reversibilità

/ Reversible / Réversibilité

Tutti i nostri divani letto sono reversibili / All of our sofa beds are reversible / Tous nos canapés convertibles sont réversibles

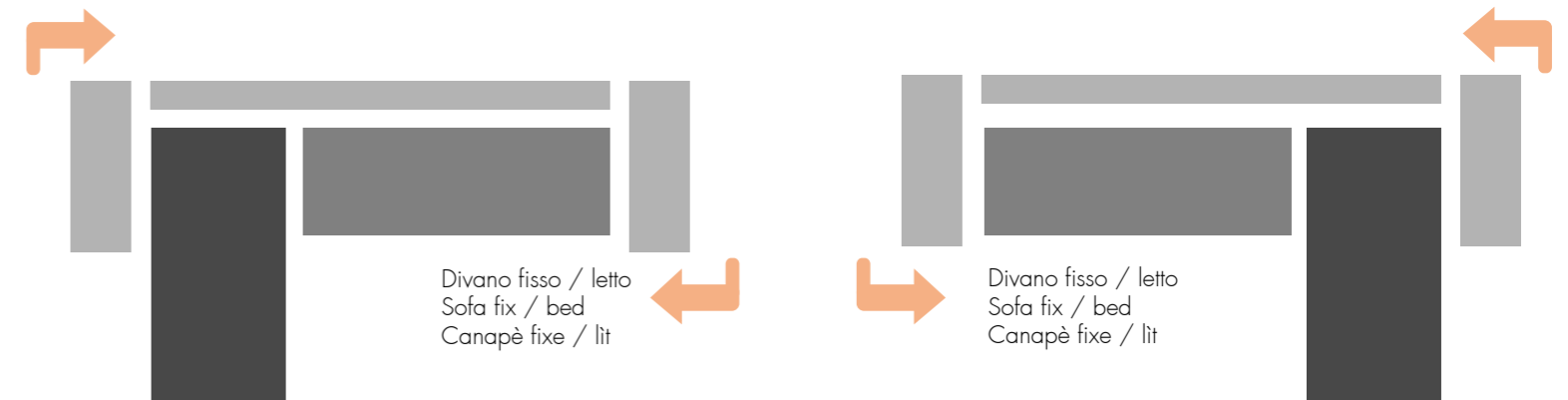

Chaiselongue fissa / apribile
Fixed / storage chaiselongue
Chaiselongue fixe / ouvrant

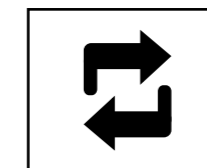

Chaiselongue fissa / apribile
Fixed / storage chaiselongue
Chaiselongue fixe / ouvrant

ALESSIA

CATEGORIA TOP

Classica microfibra di poliestere accoppiata le cui caratteristiche principali sono la mano morbida e la facile pulizia. Grazie al trattamento idrorepellente le macchie provocate da liquidi possono essere eliminate semplicemente con un panno umido.

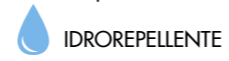

BORA WARE

CATEGORIA PREMIUM

Composizione 100% poliestere
Larghezza 140 cm +/- 2%
Peso 285 gr / m2 +/- 5%



NEW DELHI

CATEGORIA TOP

Composizione 100% poliestere
Larghezza 140 cm +/- 2%
Peso 370 gr / m2 +/- 5%

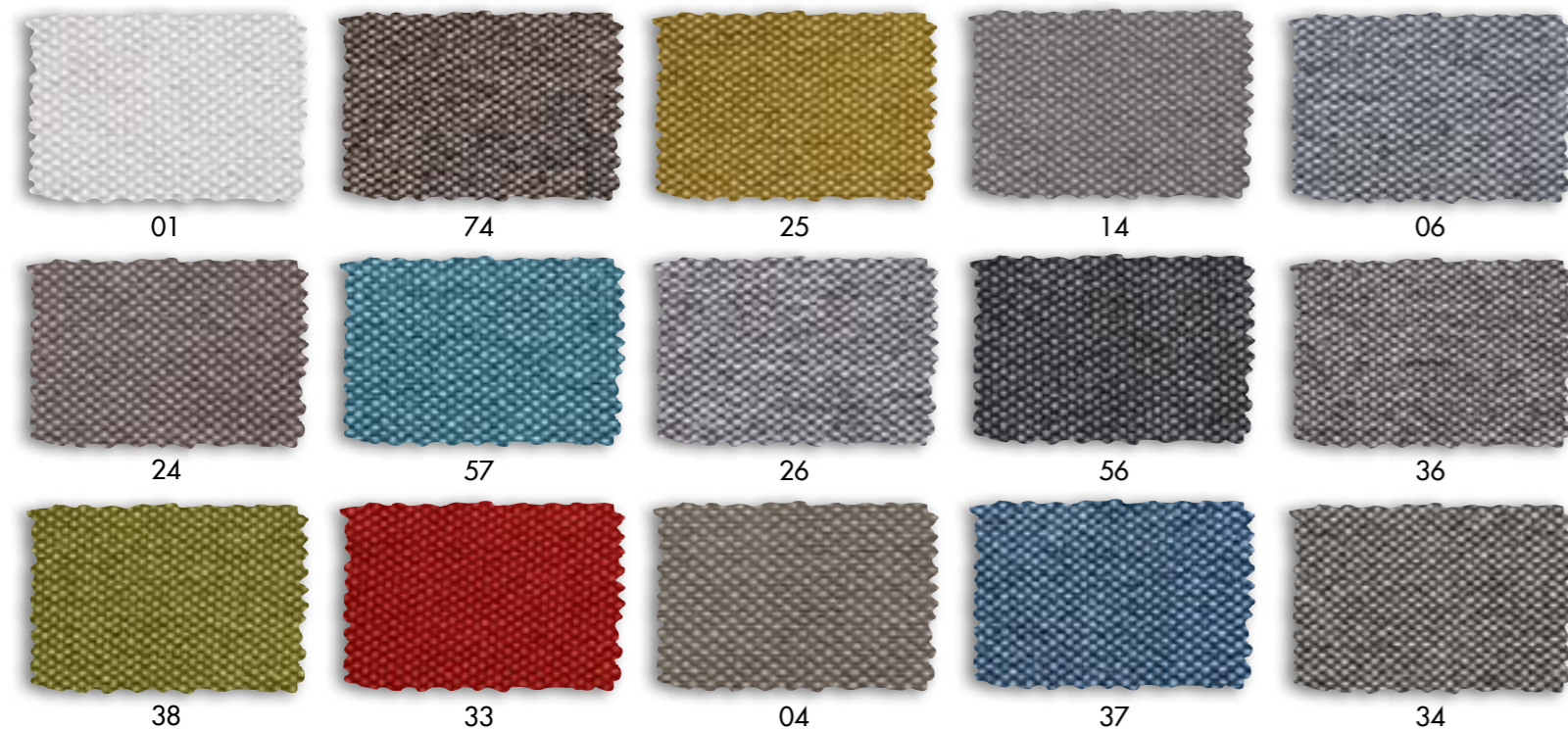

FLORIDA PLUS

CATEGORIA PREMIUM

Composizione 100% poliestere
Larghezza 140 cm +/- 2%
Peso 480 gr / m2 +/- 5%



DUBLINO

CATEGORIA PREMIUM

Composizione 100% poliestere
Larghezza 140 cm +/- 2%
Peso 370 gr / m2 +/- 5%

 IDROREPELENTE

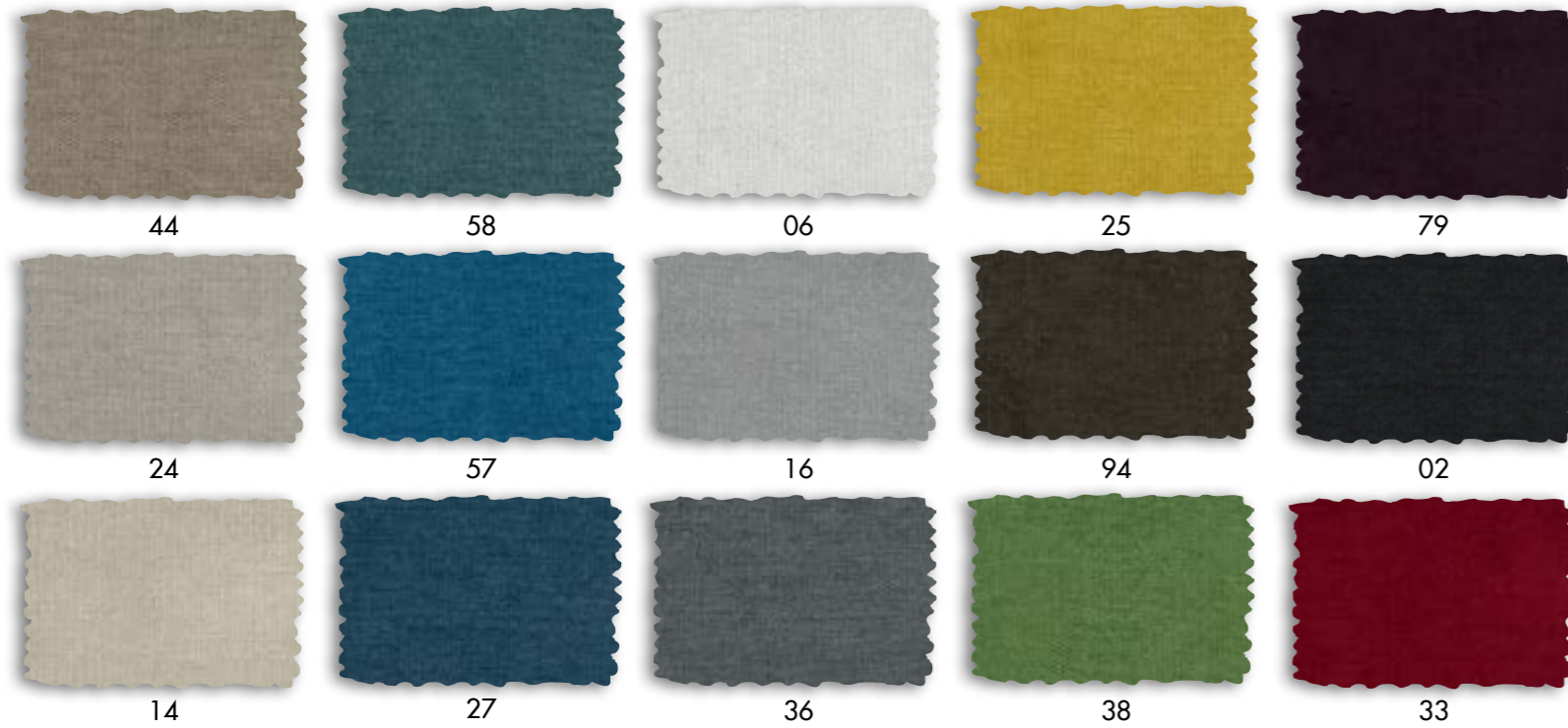

QUEBEC

CATEGORIA PREMIUM

Composizione 100% poliestere
Larghezza 140 cm +/- 2%
Peso 400 gr / m2 +/- 5%

 IDROREPELENTE

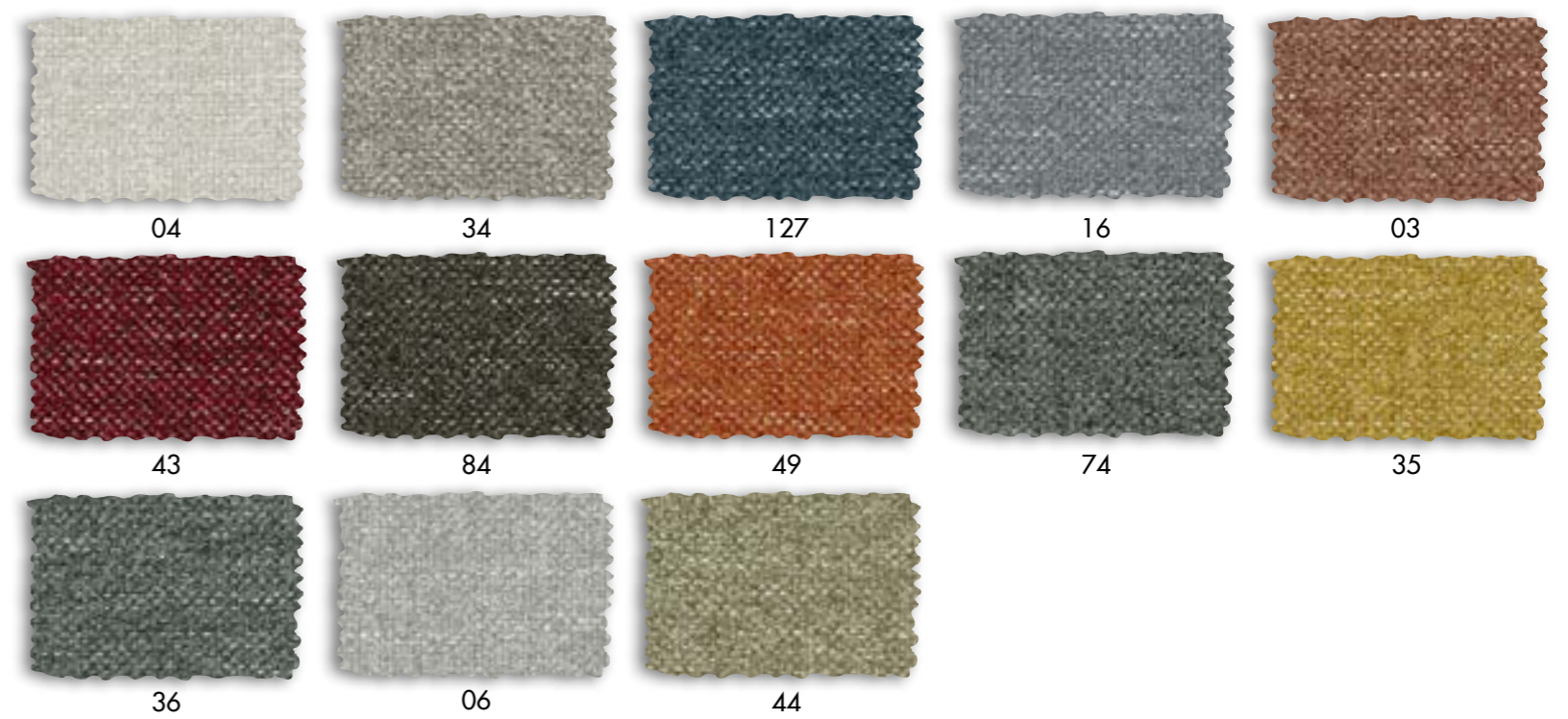

VERONA

CATEGORIA PREMIUM

Composizione 100% poliestere
Larghezza 140 cm +/- 2%
Peso 330 gr / m2 +/- 5%

 IDROREPELENTE

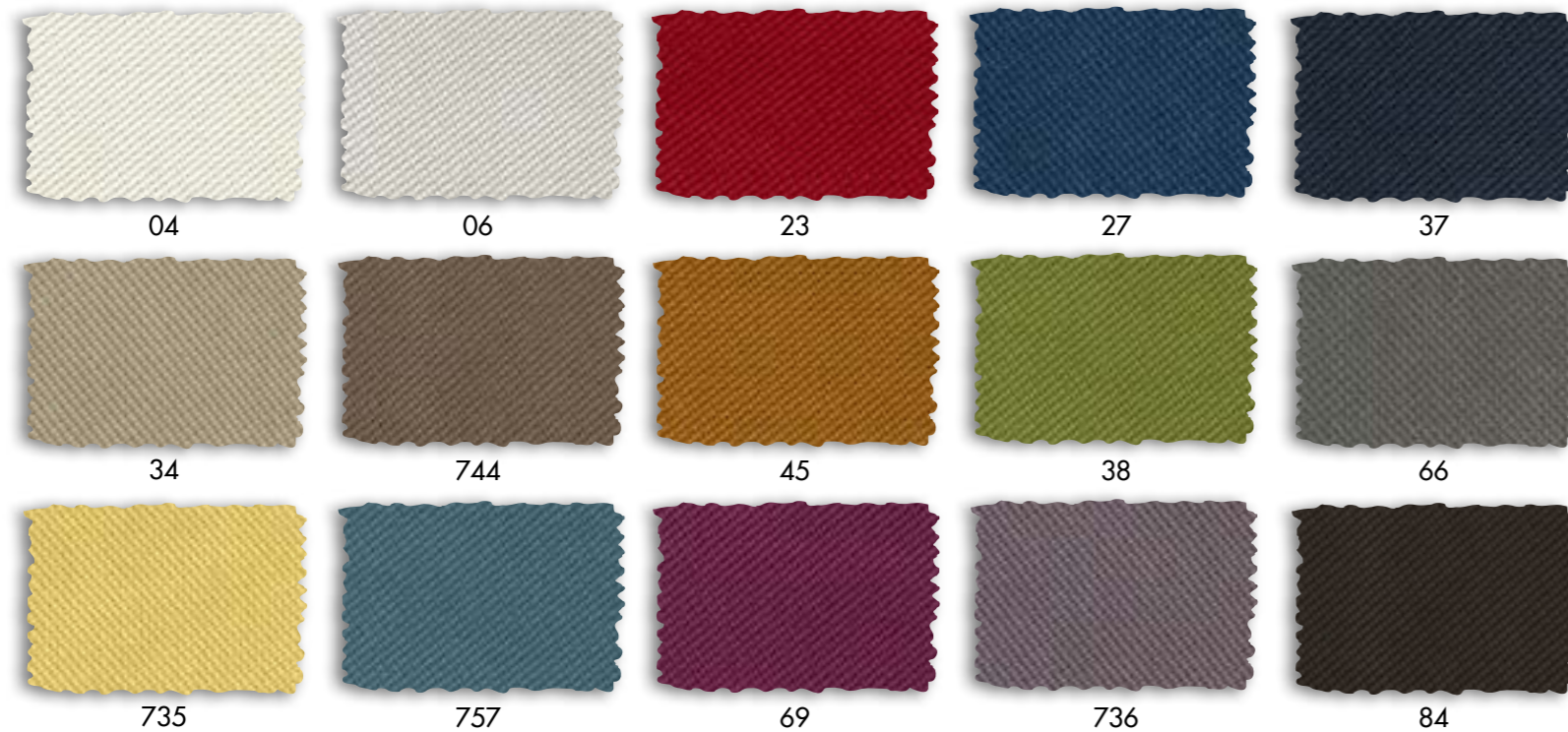

MARY

CATEGORIA PREMIUM

Composizione 100% poliestere
Peso 450 ± 5% gr/mq

LAVAGGIO A MANO A 30°



AMSTERDAM

CATEGORIA SOFT

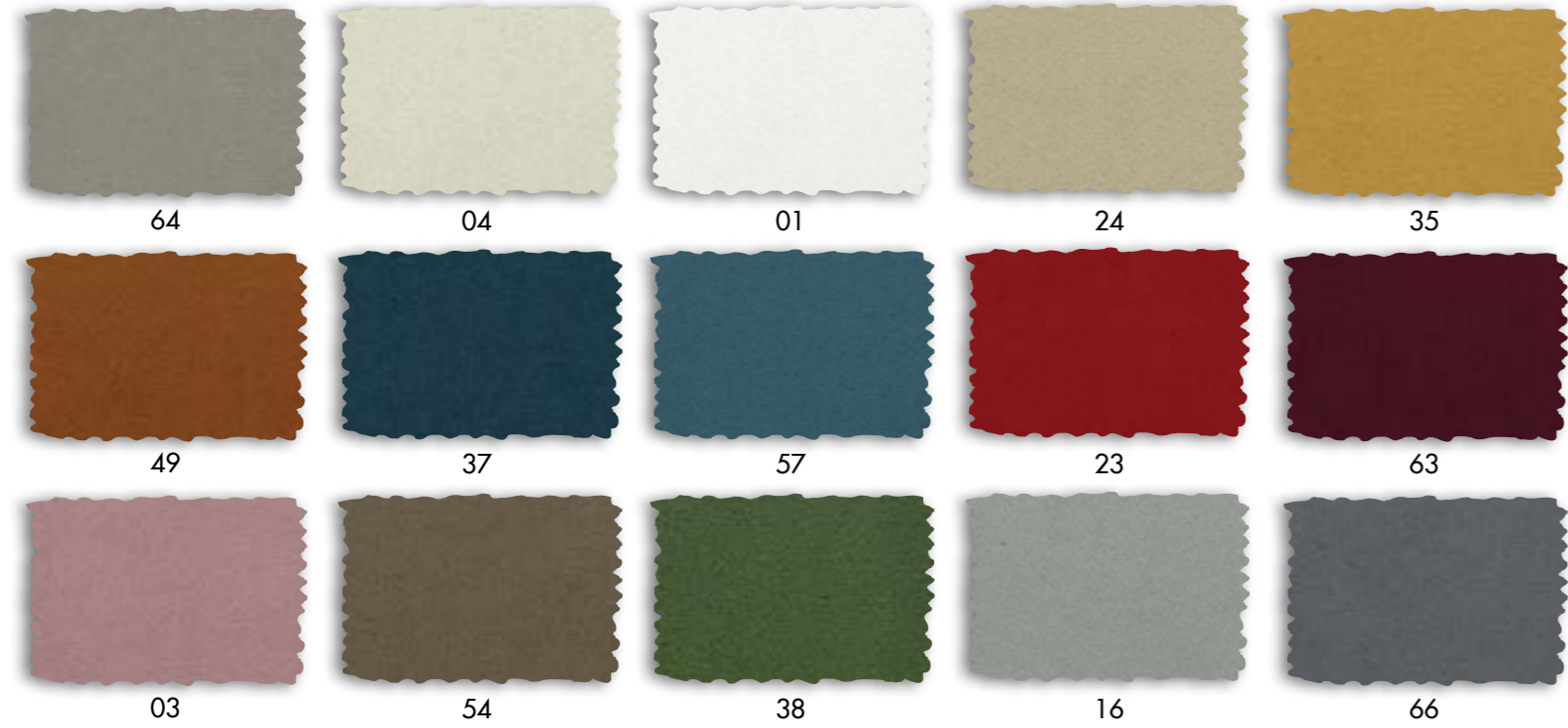

FIAMMA

CATEGORIA SOFT

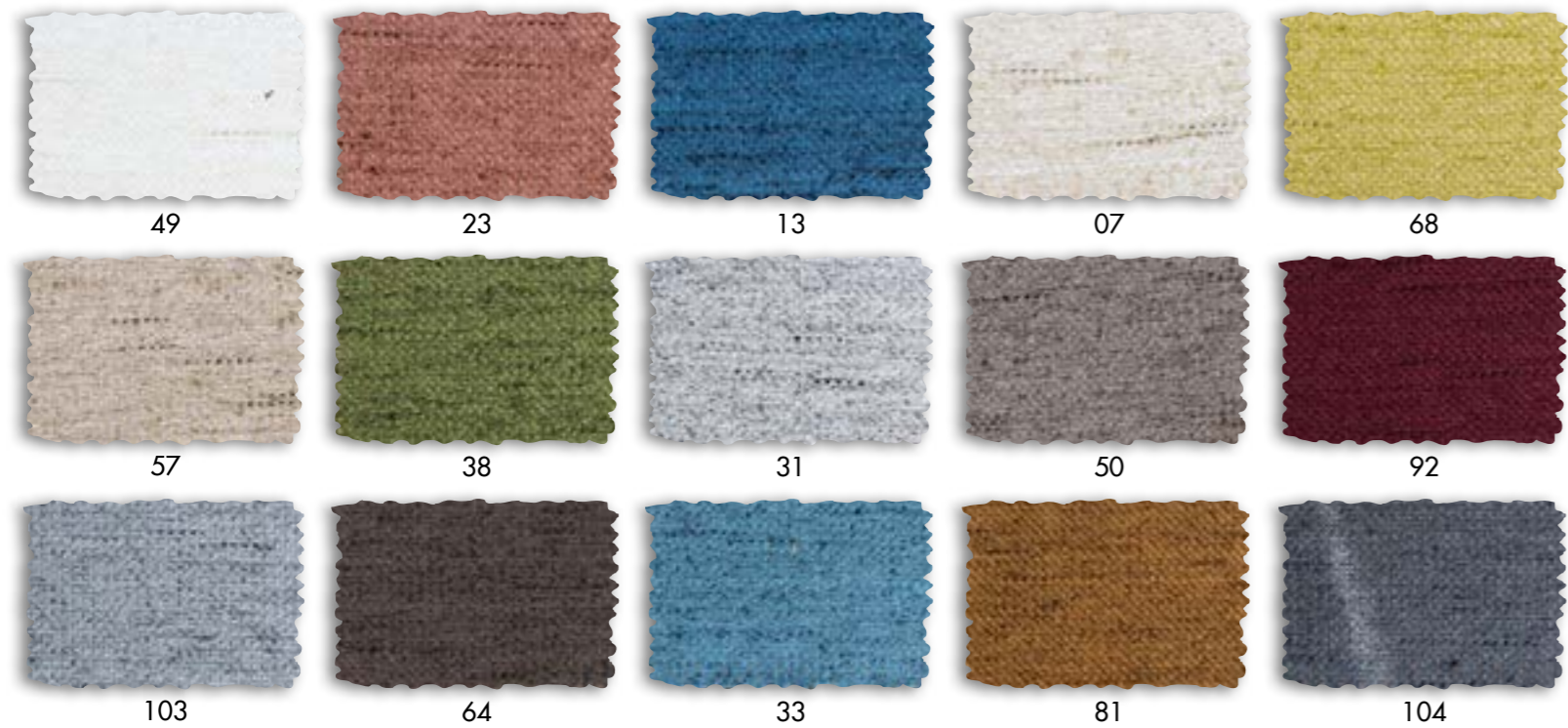

GLOBE

CATEGORIA SOFT



DREAM

CATEGORIA SOFT



CALIFORNIA

CATEGORIA PELLE / LEATHER

Aspetto semilucido / Semi-gloss appearance
Misura media : oltre 4,0 mq
Size : over 4.0 sqm
Spessore mm 1,3 - 1,5 +/- 0,1
Thickness 1,3 - 1,5 +/- 0,1 mm

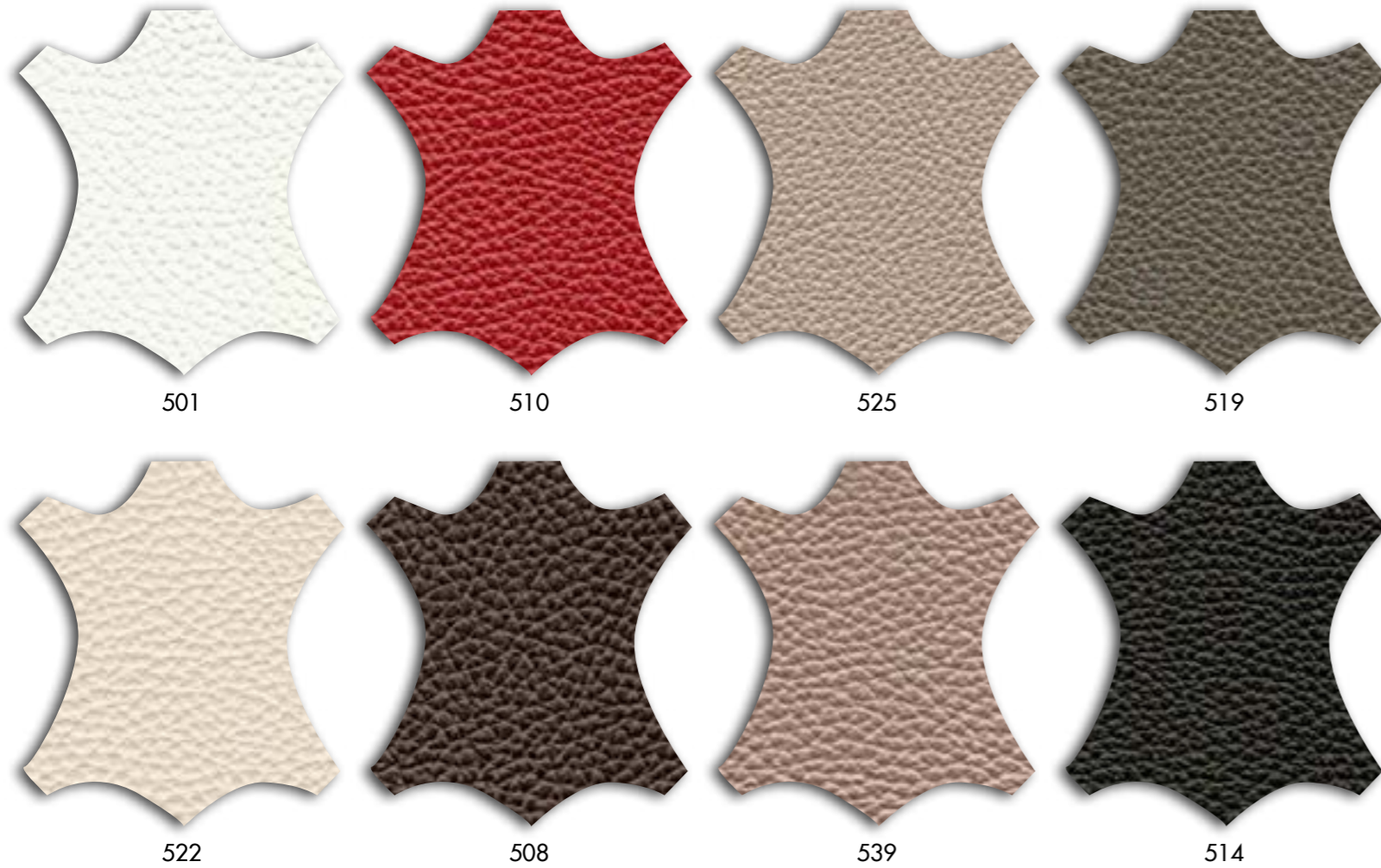

CUSCINETTI DECORO / PILLOWS



CUSCINETTO DECORO STANDARD

standard pillow

45 x 45 cm



CUSCINETTO DECORO CON BORDINO

pillow with edge

45 x 45 cm



CUSCINETTO DECORO QUADRATO CON FASCIA

square pillow with band

47 x 47 x 7 cm



CUSCINETTO DECORO RETTANGOLARE CON FASCIA

rectangular pillow with band

47 x 32 x 5 cm

Graphic design
Photography and 3D
Post-production

Loris Di Pancrazio
loris.dipancrazio@gmail.com

 **alterego**[®]

divani
MADE IN ITALY

ALTEREGO DIVANI S.R.L. a S.U.
Via gabiano, 24 - Zona ind.le S. Scolastica
64013 Corropoli (TE) - Italy - C.F. P.IVA 01626610677
Tel. (+39) 0861/910585 - fax (+39) 0861/910930
info@alteregodivani.it

www.alteregodivani.it